

# SENSAPHONE®



## **Sensaphone 1400 User's Manual**



SENSAPHONE®

**1400**

Environmental Monitoring System

*User's Manual*

*Version 2.0*

Every effort has been made to ensure that the information in this document is complete, accurate and up-to-date. Phonetics, Inc. assumes no responsibility for the results of errors beyond its control. Phonetics, Inc. also cannot guarantee that changes in equipment made by other manufacturers, and referred to in this manual, will not affect the applicability of the information in this manual.

Copyright © 2005 by Phonetics, Inc., dba SENSAPHONE®

First Edition, version 2.0, January 2017

Written and produced by Phonetics, Inc.

Please address comments on this publication to:

Phonetics, Inc.  
901 Tryens Road  
Aston, PA 19014

Sensaphone is a registered trademark of Phonetics, Inc.

## Important Safety Instructions

Your Sensaphone 1400 has been carefully designed to give you years of safe, reliable performance. As with all electrical equipment, however, there are a few basic precautions you should take to avoid hurting yourself or damaging the unit:

- Read the installation and operating instructions in this manual carefully. Be sure to save it for future reference.
- Read and follow all warning and instruction labels on the product itself.
- To protect the Sensaphone 1400 from overheating, make sure all openings on the unit are not blocked. Do not place on or near a heat source, such as a radiator or heat register.
- Do not use your Sensaphone 1400 near water, or spill liquid of any kind into it.
- Be certain that your power source matches the rating listed on the AC power transformer. If you're not sure of the type of power supply to your facility, consult your dealer or local power company.
- Do not allow anything to rest on the power cord. Do not locate this product where the cord will be abused by persons walking on it.
- Do not overload wall outlets and extension cords, as this can result in the risk of fire or electric shock.
- Never push objects of any kind into this product through ventilation holes as they may touch dangerous voltage points or short out parts that could result in a risk of fire or electric shock.
- To reduce the risk of electric shock, do not disassemble this product, but return it to Sensaphone Customer Service or another approved repair facility when any service or repair work is required. Opening or removing covers may expose you to dangerous voltages or other risks. Incorrect reassembly can cause electric shock when the unit is subsequently used.
- If anything happens that indicates that your Sensaphone 1400 is not working properly or has been damaged, unplug it immediately and follow the procedures in the manual for having it serviced. Return the unit for servicing under the following conditions:
  1. The power cord or plug is frayed or damaged.
  2. Liquid has been spilled into the product or it has been exposed to water.
  3. The unit has been dropped, or the enclosure is damaged.
  4. The unit doesn't function normally when you're following the operating instructions.
- Avoid using a telephone (other than a cordless type) during an electrical storm. There may be a remote risk of electric shock from lightning.

- Do not use the telephone to report a gas leak in the vicinity of the leak.

**CAUTION:** To reduce the risk of fire or injury to persons, read and follow these instructions:

1. Replace the battery only with the same or equivalent type recommended by the manufacturer.
2. Do not dispose of the battery in a fire. The cell may explode. Check with local codes for possible special disposal instructions.
3. Do not open or mutilate the battery. Released electrolyte is corrosive and may cause damage to the eyes or skin. It may be toxic if swallowed.
4. Exercise care in handling battery in order not to short the battery with conducting materials such as rings, bracelets, and keys. The battery or conductor may overheat and cause burns.

## FCC Requirements

Part 68: The Sensaphone 1400 complies with 47 CFR, Part 68 of the rules. On the back of the unit there is a label that contains, among other information, the Certification Number and the Ringer Equivalence Number (REN) for this equipment. You must, upon request, provide this information to your local telephone company.

The REN is useful to determine the quantity of devices that you may connect to your telephone line and still have all of those devices ring when your telephone number is called. In most, but not all areas, the sum of the REN's of all devices connected to one line should not exceed five (5.0). To be certain of the number of devices that you may connect to your line, you may want to contact your local telephone company to determine the maximum REN for your calling area.

The applicable certification jack USOC for this equipment is: RJ11C. The facility interface code (FIC) for this equipment is: 02LS2.

A compliant telephone cord and modular plug are provided with equipment. This equipment is designated to be connected to the telephone network or premises wiring using a compatible modular jack which is Part 68 compliant. See Installation Instructions for details.

This equipment may not be used on coin service units provided by the telephone company. Connection to party lines is subject to state tariffs. Contact the state public utility commission, public service commission or corporation commission for information.

Should the 1400 cause harm to the telephone network, the telephone company may discontinue your service temporarily. If possible, they will notify you in advance. But if advance notice isn't practical, the telephone company may temporarily discontinue service without notice and you will be notified as soon as possible. You will be informed of your right to file a complaint with the FCC. The telephone company may make changes in its facilities, equipment, operations, or procedures where such action is reasonably required in the operation of its business and is not inconsistent with the rules and regulations of the FCC that could affect the proper functioning of your equipment. If they do, you will be notified in advance to give you an opportunity to maintain uninterrupted telephone service.

If you experience trouble with the 1400, or you need information on obtaining service or repairs, please contact:

Phonetics, Inc.

901 Tryens Road

Aston, PA 19014

Toll-Free: 1-877-373-2700

FAX: 610-558-0222

If the equipment is causing harm to the telephone network, the telephone company may ask that you disconnect this equipment from the network until the problem has been corrected or until you are sure that the equipment is not malfunctioning.

Part 15: This equipment has been tested and found to comply with the limits for a Class A digital device, pursuant to Part 15 of the FCC Rules. These limits are designed to provide reasonable protection against harmful interference when the equipment is operated in a commercial environment. This equipment generates, uses and can radiate radio frequency energy and, if not installed and used in accordance with the instructions, may cause harmful interference to radio communications. Operation of this equipment in a residential area is likely to cause harmful interference in which case the user will be required to correct the interference at his own expense.

### General Requirements for all Automatic Dialers

When programming emergency numbers and (or) making test calls to emergency numbers:

1. Remain on the line and briefly explain to the dispatcher the reason for the call.
2. Perform such activities in the off-peak hours, such as early morning or late evenings.

# Canadian Department of Communications Statement

**Notice:** The Canadian Department of Communications label identifies certified equipment. This certification means that the equipment meets certain telecommunications network protective operational and safety requirements. The Department does not guarantee the equipment will operate to the user's satisfaction.

Before installing this equipment, users should ensure that it is permissible to be connected to the facilities of the local telecommunications company. The equipment must also be installed using an acceptable method of connection. In some cases, the company's inside wiring associated with a single line individual service may be extended by means of a certified connector assembly (telephone extension cord). The customer should be aware that compliance with the above conditions may not prevent degradation of service in some situations.

Repairs to certified equipment should be made by an authorized Canadian maintenance facility designated by the supplier. Any repairs or alterations made by the user to this equipment, or equipment malfunctions, may give the telecommunications company cause to request the user to disconnect the equipment.

Users should ensure for their own protection that the electrical ground connections of the power utility, telephone lines and internal metallic water pipe system, if present, are connected together. This precaution may be particularly important in rural areas.

**CAUTION:** Users should not attempt to make such connections themselves, but should contact the appropriate electric inspection authority, or electrician, as appropriate.

The Ringer Equivalence Number (REN) assigned to each terminal device denotes the percentage of the total load to be connected to a telephone loop which is used by the device to prevent overloading. The termination on a loop may consist of any combination of devices subject only to the requirement that the total of the Ringer Equivalent Numbers of all the devices does not exceed 5.0. For Sensaphone 1400, the AC Ringer Equivalent Number is 0.6B.



## 2 YEAR LIMITED WARRANTY

PLEASE READ THIS WARRANTY CAREFULLY BEFORE USING THE PRODUCT.

THIS LIMITED WARRANTY CONTAINS SENSAPHONE'S STANDARD TERMS AND CONDITIONS. WHERE PERMITTED BY THE APPLICABLE LAW, BY KEEPING YOUR SENSAPHONE PRODUCT BEYOND THIRTY (30) DAYS AFTER THE DATE OF DELIVERY, YOU FULLY ACCEPT THE TERMS AND CONDITIONS SET FORTH IN THIS LIMITED WARRANTY.

IN ADDITION, WHERE PERMITTED BY THE APPLICABLE LAW, YOUR INSTALLATION AND/OR USE OF THE PRODUCT CONSTITUTES FULL ACCEPTANCE OF THE TERMS AND CONDITIONS OF THIS LIMITED WARRANTY (HEREINAFTER REFERRED TO AS "LIMITED WARRANTY OR WARRANTY"). IF YOU DO NOT AGREE TO THE TERMS AND CONDITIONS OF THIS WARRANTY, INCLUDING ANY LIMITATIONS OF WARRANTY, INDEMNIFICATION TERMS OR LIMITATION OF LIABILITY, THEN YOU SHOULD NOT USE THE PRODUCT AND SHOULD RETURN IT TO THE SELLER FOR A REFUND OF THE PURCHASE PRICE. THE LAW MAY VARY BY JURISDICTION AS TO THE APPLICABILITY OF YOUR INSTALLATION OR USE ACTUALLY CONSTITUTING ACCEPTANCE OF THE TERMS AND CONDITIONS HEREIN AND AS TO THE APPLICABILITY OF ANY LIMITATION OF WARRANTY, INDEMNIFICATION TERMS OR LIMITATIONS OF LIABILITY.

1. **WARRANTOR:** In this Warranty, Warrantor shall mean "Dealer, Distributor, and/or Manufacturer."
2. **ELEMENTS OF WARRANTY:** This Product is warranted to be free from defects in materials and craftsmanship with only the limitations and exclusions set out below.
3. **WARRANTY AND REMEDY:** Two-Year Warranty — In the event that the Product does not conform to this warranty at any time during the time of two years from original purchase, warrantor will repair the defect and return it to you at no charge.

This warranty shall terminate and be of no further effect at the time the product is: (1) damaged by extraneous cause such as fire, water, lightning, etc. or not maintained as reasonable and necessary; or (2) modified; or (3) improperly installed; or (4) misused; or (5) repaired or serviced by someone other than Warrantors' authorized personnel or someone expressly authorized by Warrantor's to make such service or repairs; (6) used in a manner or purpose for which the product was not intended; or (7) sold by original purchaser.

LIMITED WARRANTY, LIMITATION OF DAMAGES AND DISCLAIMER OF LIABILITY FOR DAMAGES: THE WARRANTOR'S OBLIGATION

UNDER THIS WARRANTY IS LIMITED TO REPAIR OR REPLACEMENT OF THE PRODUCT, AT THE WARRANTOR'S OPTION AS TO REPAIR OR REPLACEMENT. IN NO EVENT SHALL WARRANTORS BE LIABLE OR RESPONSIBLE FOR PAYMENT OF ANY INCIDENTAL, CONSEQUENTIAL, SPECIAL AND/OR PUNITIVE DAMAGES OF ANY KIND, INCLUDING BUT NOT LIMITED TO ANY LABOR COSTS, PRODUCT COSTS, LOST REVENUE, BUSINESS INTERRUPTION LOSSES, LOST PROFITS, LOSS OF BUSINESS, LOSS OF DATA OR INFORMATION, OR FINANCIAL LOSS, FOR CLAIMS OF ANY NATURE, INCLUDING BUT NOT LIMITED TO CLAIMS IN CONTRACT, BREACH OF WARRANTY OR TORT, AND WHETHER OR NOT CAUSED BY WARRANTORS' NEGLIGENCE. IN THE EVENT THAT IT IS DETERMINED IN ANY ADJUDICATION THAT THE LIMITED WARRANTIES OF REPAIR OR REPLACEMENT ARE INAPPLICABLE, THEN THE PURCHASER'S SOLE REMEDY SHALL BE PAYMENT TO THE PURCHASER OF THE ORIGINAL COST OF THE PRODUCT, AND IN NO EVENT SHALL WARRANTORS BE LIABLE OR RESPONSIBLE FOR PAYMENT OF ANY INCIDENTAL, CONSEQUENTIAL, SPECIAL AND/OR PUNITIVE DAMAGES OF ANY KIND, INCLUDING BUT NOT LIMITED TO ANY LOST REVENUE, BUSINESS INTERRUPTION LOSSES, LOST PROFITS, LOSS OF BUSINESS, LOSS OF DATA OR INFORMATION, OR FINANCIAL LOSS, FOR CLAIMS OF ANY NATURE, INCLUDING BUT NOT LIMITED TO CLAIMS IN CONTRACT, BREACH OF WARRANTY OR TORT, AND WHETHER OR NOT CAUSED BY WARRANTORS' NEGLIGENCE.

WITHOUT WAIVING ANY PROVISION IN THIS LIMITED WARRANTY, IF A CIRCUMSTANCE ARISES WHERE WARRANTORS ARE FOUND TO BE LIABLE FOR ANY LOSS OR DAMAGE ARISING OUT OF MISTAKES, NEGLIGENCE, OMISSIONS, INTERRUPTIONS, DELAYS, ERRORS OR DEFECTS IN WARRANTORS' PRODUCTS OR SERVICES, SUCH LIABILITY SHALL NOT EXCEED THE TOTAL AMOUNT PAID BY THE CUSTOMER FOR WARRANTORS' PRODUCT AND SERVICES OR \$250.00, WHICHEVER IS GREATER. YOU HEREBY RELEASE WARRANTORS FROM ANY AND ALL OBLIGATIONS, LIABILITIES AND CLAIMS IN EXCESS OF THIS LIMITATION.

INDEMNIFICATION AND COVENANT NOT TO SUE: YOU WILL INDEMNIFY, DEFEND AND HOLD HARMLESS WARRANTORS, THEIR OWNERS, DIRECTORS, OFFICERS, EMPLOYEES, AGENTS, SUPPLIERS OR AFFILIATED COMPANIES, AGAINST ANY AND ALL CLAIMS, DEMANDS OR ACTIONS BASED UPON ANY LOSSES, LIABILITIES, DAMAGES OR COSTS, INCLUDING BUT NOT LIMITED TO DAMAGES THAT ARE DIRECT OR INDIRECT, INCIDENTAL, SPECIAL OR CONSEQUENTIAL, AND INCLUDING ATTORNEYS FEES AND LEGAL COSTS, THAT MAY RESULT FROM THE INSTALLATION, OPERATION, USE OF, OR INABILITY TO USE WARRANTORS' PRODUCTS AND SERVICES, OR FROM THE FAILURE OF THE WARRANTORS' SYSTEM

TO REPORT A GIVEN EVENT OR CONDITION, WHETHER OR NOT CAUSED BY WARRANTORS' NEGLIGENCE.

YOU AGREE TO RELEASE, WAIVE, DISCHARGE AND COVENANT NOT TO SUE WARRANTORS, THEIR OWNERS, DIRECTORS, OFFICERS, EMPLOYEES, AGENTS, SUPPLIERS OR AFFILIATED COMPANIES, FOR ANY AND ALL LIABILITIES POTENTIALLY ARISING FROM ANY CLAIM, DEMAND OR ACTION BASED UPON ANY LOSSES, LIABILITIES, DAMAGES OR COSTS, INCLUDING BUT NOT LIMITED TO DAMAGES THAT ARE DIRECT OR INDIRECT, INCIDENTAL, SPECIAL OR CONSEQUENTIAL, AND INCLUDING ATTORNEYS FEES AND LEGAL COSTS, THAT MAY RESULT FROM THE INSTALLATION, OPERATION, USE OF, OR INABILITY TO USE WARRANTORS' PRODUCTS AND SERVICES, OR FROM THE FAILURE OF THE WARRANTORS' SYSTEM TO REPORT A GIVEN EVENT OR CONDITION, WHETHER OR NOT CAUSED BY WARRANTORS' NEGLIGENCE, EXCEPT AS NECESSARY TO ENFORCE THE EXPRESS TERMS OF THIS LIMITED WARRANTY.

EXCLUSIVE WARRANTY: THE LIMITED WARRANTY OR WARRANTIES DESCRIBED HEREIN CONSTITUTE THE SOLE WARRANTY OR WARRANTIES TO THE PURCHASER. ALL IMPLIED WARRANTIES ARE EXPRESSLY DISCLAIMED, INCLUDING: THE WARRANTY OF MERCHANTABILITY AND THE WARRANTY OF FITNESS FOR A PARTICULAR USE AND THE WARRANTY OF FITNESS FOR A PARTICULAR PURPOSE AND THE WARRANTY OF NON-INFRINGEMENT AND/OR ANY WARRANTY ARISING FROM A COURSE OF DEALING, USAGE, OR TRADE PRACTICE.

It must be clear that the Warrantors are not insuring your premises or business or guaranteeing that there will not be damage to your person or property or business if you use this Product. You should maintain insurance coverage sufficient to provide compensation for any loss, damage, or expense that may arise in connection with the use of products or services, even if caused by Warrantors' negligence. The warrantors assume no liability for installation of the Product and/or interruptions of the service due to strikes, riots, floods, fire, and/or any cause beyond Seller's control, further subject to the limitations expressed in any License Agreement or other Agreement provided by Warrantors to purchaser.

The agreement between the Warrantors and the Purchaser, including but not limited to the terms and conditions herein shall not be governed by the Convention for the International Sale of Goods. Where applicable, the Uniform Commercial Code as adopted by the State of Delaware shall apply.

4. PROCEDURE FOR OBTAINING PERFORMANCE OF WARRANTY: In the event that the Product does not conform to this warranty, the Product should be shipped or delivered freight prepaid to a Warrantor with evidence of original purchase.

5. LEGAL REMEDIES AND DISCLAIMER: Some jurisdictions may not allow, or may place limits upon, the exclusion and/or limitation of implied warranties, incidental damages and/or consequential damages for some types of goods or products sold to consumers and/or the use of indemnification terms. Thus, the exclusions, indemnification terms and limitations set out above may not apply, or may be limited in their application, to you. If the implied warranties can not be excluded, and the applicable law permits limiting the duration of implied warranties, then the implied warranties herein are to be limited to the same duration as the applicable written warranty or warranties herein. The warranty or warranties herein may give you specific legal rights that will depend upon the applicable law. You may also have other legal rights depending upon the law in your jurisdiction.

6. CHOICE OF FORUM AND CHOICE OF LAW: In the event that a dispute arises out of or in connection with this Limited Warranty, then any claims or suits of any kind concerning such disputes shall only and exclusively be brought in either the Court of Common Pleas of Delaware County, Pennsylvania or the United States District Court for the Eastern District of Pennsylvania.

Regardless of the place of contracting or performance, this Limited Warranty and all questions relating to its validity, interpretation, performance and enforcement shall be governed by and construed in accordance with the laws of the State of Delaware, without regard to the principles of conflicts of law.

Effective date 08/01/2005  
PHONETICS, INC. d.b.a. SENSAPHONE  
901 Tryens Road  
Aston, PA 19014  
Phone: 610.558.2700 Fax: 610.558.0222  
[www.sensaphone.com](http://www.sensaphone.com)

# Table of Contents

Important Safety Instructions . . . . .	iii
FCC Requirements . . . . .	v
Canadian Department of Communications Statement. . .	vii
2 YEAR LIMITED WARRANTY. . . . .	ix
<b>CHAPTER 1: INTRODUCTION . . . . .</b>	<b>17</b>
<b>FEATURES . . . . .</b>	<b>18</b>
<b>LAYOUT . . . . .</b>	<b>19</b>
<b>CHAPTER 2: INSTALLATION . . . . .</b>	<b>21</b>
<b>OPERATING ENVIRONMENT . . . . .</b>	<b>21</b>
<b>Mounting the 1400. . . . .</b>	<b>21</b>
Locking the Enclosure . . . . .	22
Grounding . . . . .	22
<b>Wiring Connectors . . . . .</b>	<b>23</b>
<b>TURNING THE 1400 ON . . . . .</b>	<b>24</b>
Backup Battery . . . . .	24
<b>TELEPHONE LINE . . . . .</b>	<b>24</b>
Line Seizure . . . . .	25
<b>WIRING SENSORS AND TRANSDUCERS. . . . .</b>	<b>25</b>
External Microphone . . . . .	27
Wiring Recommendations . . . . .	27
<b>LED INDICATORS. . . . .</b>	<b>28</b>
<b>CHAPTER 3: QUICK START GUIDE . . . . .</b>	<b>29</b>
<b>HOW THE KEYPAD COMMANDS WORK. . . . .</b>	<b>29</b>
<b>ABORTING A COMMAND. . . . .</b>	<b>29</b>
<b>ERROR MESSAGES . . . . .</b>	<b>29</b>
<b>ACKNOWLEDGING A FALSE ALARM. . . . .</b>	<b>30</b>
<b>RECOMMENDED PROGRAMMING STEPS . . . . .</b>	<b>30</b>

**CHAPTER 4: ZONE PROGRAMMING . . . . . 31**

- AUTOMATIC ZONE CONFIGURATION . . . . . 31**
- MANUAL ZONE CONFIGURATION . . . . . 32**
- ENABLE/DISABLE ZONE ALARMS . . . . . 34**
- ENABLE/DISABLE SOUND LEVEL ALARM . . . . . 34**
- ENABLE/DISABLE POWER . . . . . 35**
- CONFIGURE TEMPERATURE SCALE . . . . . 35**
- CONFIGURE TABLE RANGE FOR 4–20MA SENSORS. . 36**
- ALARM RECOGNITION TIME . . . . . 38**
- ALARM LIMITS . . . . . 40**
- RESET TIME. . . . . 42**
- ZONE CALIBRATION . . . . . 44**
- SOUND LEVEL CALIBRATION. . . . . 45**
- DESIGNATING A ZONE AS UNUSED . . . . . 47**
- EXIT DELAY . . . . . 48**
- TEMPERATURE-ONLY STATUS REPORT. . . . . 49**

**CHAPTER 5: COMMUNICATION PROGRAMMING . . . . . 50**

- DATE AND TIME . . . . . 51**
- VOICE MESSAGES . . . . . 52**
- ID NUMBER. . . . . 56**
- ALARM DIAL-OUT TELEPHONE NUMBERS . . . . . 58**
  - Voice Dialout . . . . . 58**
  - Numeric Pager Dialout. . . . . 60**
- SPECIAL DIALING OPTIONS. . . . . 64**
  - Change to Touch-Tone Dialing . . . . . 65
  - Special Dialing Code Summary . . . . . 65
- DIAL-OUT TEST MODE . . . . . 66**
  - To manually dial a phone number: . . . . . 66
- ALARM ACKNOWLEDGMENT CODES . . . . . 68**
  - To erase an Acknowledgment Code: . . . . . 70
- ALARM HISTORY. . . . . 71**
  - Deleting the Alarm History: . . . . . 71

<b>TONE OR PULSE DIALING</b> .....	<b>72</b>
<b>RINGS UNTIL ANSWER.</b> .....	<b>73</b>
<b>CALL DELAY TIME.</b> .....	<b>74</b>
<b>INTERCALL TIME.</b> .....	<b>76</b>
<b>CALL PROGRESS.</b> .....	<b>78</b>
<b>VOICE REPETITIONS</b> .....	<b>79</b>
<b>MAX CALLS</b> .....	<b>80</b>
<b>TELEPHONE ANSWERING DEVICE (TAD)</b>	
<b>COMPATIBILITY.</b> .....	<b>82</b>
<b>LISTEN-IN TIME</b> .....	<b>83</b>
<b>REMOTE PROGRAMMING SECURITY CODE (LOCK)</b> ..	<b>84</b>
<b>SPEAKER MUTE.</b> .....	<b>86</b>
<b>CALLBACK ACKNOWLEDGMENT.</b> .....	<b>87</b>
<b>CHAPTER 6: CONTROLLING THE OUTPUT.</b> ..	<b>88</b>
<b>AUTOMATIC MODES</b> .....	<b>88</b>
<b>MANUAL MODE</b> .....	<b>89</b>
<b>CHAPTER 7: OPERATION</b> .....	<b>91</b>
<b>ALARM DIALOUT AND ACKNOWLEDGMENT.</b> .....	<b>91</b>
Alarm Recognition. ....	91
Alarm Notification. ....	91
Dialout Note: Call Progress .....	91
Alarm Dialout—Voice .....	91
Alarm Dialout—Pager .....	92
<b>ALARM ACKNOWLEDGMENT</b> .....	<b>93</b>
Alarm Acknowledgment—Voice Dialout. ....	93
Alarm Acknowledgment—Numeric Pager Dialout . . .	94
Alarm Acknowledgment—Automatic (Max Calls) . . .	95
<b>CALL-IN STATUS</b> .....	<b>96</b>
<b>REMOTE COMMANDS VIA TOUCH-TONE PHONE</b> . . . .	<b>97</b>

**APPENDIX A: Checking Your Sensaphone 1400 for Proper Operation . . . . . 101**

**APPENDIX B: Replacing the Back-up Battery . . . . . 103**

**APPENDIX C: Troubleshooting the 1400 . . 105**  
COMMUNICATIONS/DIAL-OUT: . . . . . 106  
TEMPERATURE MONITORING: . . . . . 109  
4-20MA MONITORING: . . . . . 111  
SOUND LEVEL MONITORING: . . . . . 112  
OTHER MONITORING: . . . . . 113

**APPENDIX D: 2.8 and 10K Thermistor Tables. . . . . 115**

**APPENDIX E: 1400 Technical Specifications . . . . . 117**

**APPENDIX F: 1400 Quick Reference Guide . . . . . 119**

**APPENDIX G: Accessories . . . . . 123**

**APPENDIX H: Returning Your 1400 for Repair . . . . . 124**

**Test Log . . . . . 128**

## CHAPTER 1: INTRODUCTION

Congratulations on your purchase of the Sensaphone 1400. The 1400 is a powerful monitoring, alarm, and event logging system. It can monitor equipment and environmental conditions using four universal Zones with scaleable range, built-in power failure detection, sound level monitoring, and one relay output for manual control, or automatic control from alarms. The Sensaphone 1400 also features user-recordable voice for ID and all monitored zones, numeric paging, and built-in line seizure.

The Sensaphone 1400 is a fully programmable environmental monitoring system for unattended or remote applications. The unit will monitor and alarm on four zones: these can be N.O./N.C.(Normally Open or Normally Closed) contact, 4–20mA, or 2.8K or 10K thermistor (temperature sensor). The unit will also monitor AC power, sound level, and battery condition. On the front of the unit are LED indicators to show the operating status. Each zone (including power, sound and battery) has a status LED indicating the alarm status of the Zone. There is also an LED to indicate if the Output is On, an LED for Phone In-Use status and an LED for System-On status.

The unit is programmed using the built-in keypad and voice response menus. All programming is stored in nonvolatile memory so that all programming is retained even without power. The unit is capable of performing alarm event logging of the four universal Zones, power, and sound. The event logging (history) is also stored in nonvolatile memory. A battery-backed real-time clock is also included to time-stamp logged events. The alarm event history can be heard through the built-in speaker or remotely over the telephone. A complete status report of all monitored conditions can also be heard simply by calling the 1400.

The unit comes in a plastic NEMA-4 enclosure with tabs for wall or panel mounting. Terminal connections for Zones, outputs and power are easily accessible from the front of the unit. The 1400 is powered by a plug-in adapter and has a 6V 1.3AH rechargeable backup battery located behind the panel. Circuitry in the unit will maintain

precise charging of the battery system. The unit also includes built-in Line Seizure capability to ensure that the telephone line is available when necessary.

## **FEATURES**

The Sensaphone 1400 Includes the following features:

- Four Zones configurable as temperature, 4–20mA, or dry contact
- Scaleable Range for 4–20mA Zones
- Calibration for each Zone
- Each Zone can be individually enabled or disabled
- Power monitor
- Fully automatic input configuration. No Jumpers!
- High sound-level monitor (w/optional external mic)
- 1 relay output (manual or automatic control)
- 10 status LEDs
- Dial out to eight telephone numbers
- User-recordable voice messages
- Alarm dialout via voice and numeric pager
- Built-in Line Seizure
- Microphone for on-site listen-in (w/optional external mic)
- Time-stamped Alarm History
- Surge protection on all Zones, telephone line and power supply
- Rechargeable battery backup
- NEMA-4 enclosure

# LAYOUT

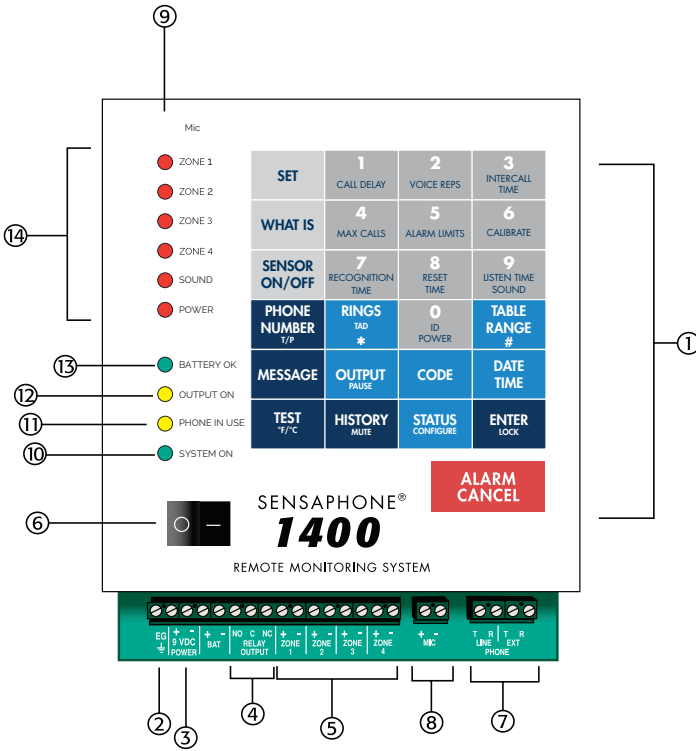

Figure 1: 1400 diagram

- |                                      |                           |
|--------------------------------------|---------------------------|
| 1. Programming Keypad                | 8. External Mic Terminals |
| 2. Grounding Terminal                | 9. Built-in Condenser Mic |
| 3. 9-12VDC Power Terminals           | 10. System On LED         |
| 4. N.O./N.C. Relay Output Terminals  | 11. Phone-in-use LED      |
| 5. 4 Zone Terminals                  | 12. Output On LED         |
| 6. Power Button                      | 13. Battery OK LED        |
| 7. Phone Network/Extension Terminals | 14. Zone Alarm LEDs       |

## **TECHNICAL SUPPORT**

Reading this instruction manual will help you install and program the 1400 easily. Programming and voice recording are performed locally using the built-in keypad. Some programming can also be accessed via touch-tone phone.

If there are any questions or problems that arise upon installation or operation, please contact Technical Support at:

SENSAPHONE  
901 Tryens Road  
Aston, PA 19014  
Toll-Free Phone: 1-877-373-2700  
FAX: 610-558-0222  
[support@sensaphone.com](mailto:support@sensaphone.com)

## CHAPTER 2: INSTALLATION

### OPERATING ENVIRONMENT

The Sensaphone 1400 should be mounted and operated in a clean, dry environment. The unit is microprocessor-controlled and as a result it should not be installed near devices that generate strong electromagnetic fields. Such interference is typically generated by power switching equipment such as relays or contactors. A poor operating environment may result in unwanted system resets and/or system lockup. The temperature range the unit can operate in is 32°F to 122°F (0°C to 50°C). If the unit needs to operate below freezing, a heater should be installed nearby.

### Mounting the 1400

The NEMA-4 enclosure comes with hardware for wall or panel mounting. The four tabs are attached by screwing the round bubble-end of a tab to each of the four rear corners of the enclosure. Then mount the unit in a position that allows easy access to the Zone terminal block and keypad. Also, there must be a power outlet and telephone jack close to the unit.

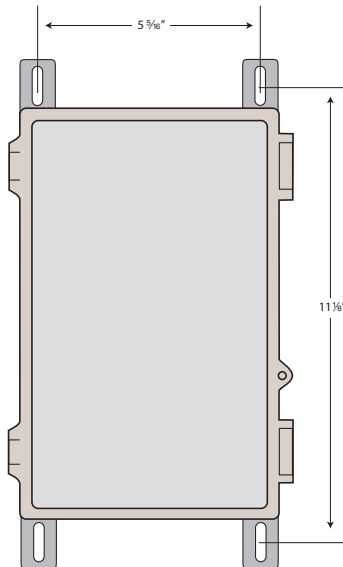

Figure 1: Mounting Dimensions

## Locking the Enclosure

The 1400 enclosure can be locked by installing a small luggage-style padlock through the loop on the front door of the enclosure. See Figure below.

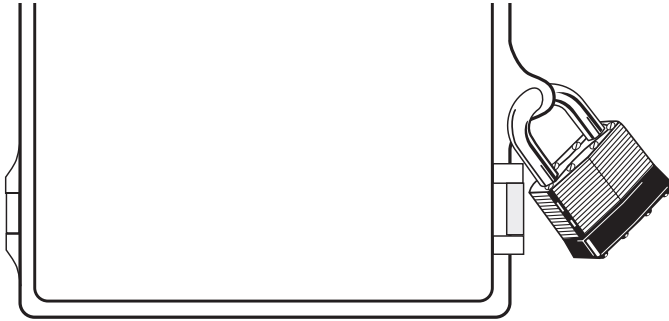

Figure 2: Locking the Enclosure

## Grounding

Connect a heavy gauge (#14AWG) copper wire to the earth ground terminal on the left end of the panel and connect the other end to a ground rod or metal cold water pipe (See Figure 3). It is extremely important that the earth ground connection be as short as possible. The ground rod should have sufficient depth to provide a low impedance connection to earth. This connection is required for the surge/lightning protection circuits to function properly.

**NOTE:** Proper earth grounding of the 1400 is required for warranty coverage.

Ground rods can typically be found at local electrical supply houses and/or hardware stores. Be sure to contact your state “*Call before you dig*” hotline at least **two** days before you install your ground rod, to insure that it is safe to install the ground rod in a chosen area.

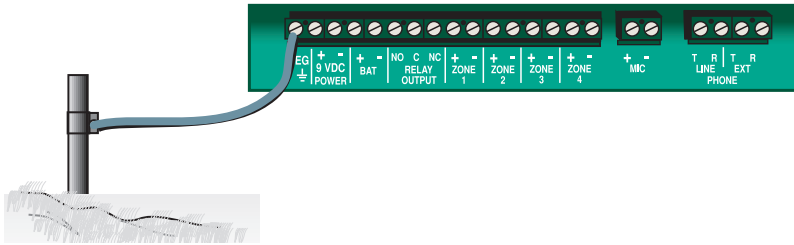

Figure 3: Grounding the 1400

## Wiring Connectors

The 1400 includes compression-type liquid-tight connectors for routing wires into the enclosure. To use these connectors, turn them *counter-clockwise to loosen* (or open-up) the compression washer. Insert all cables through the two connectors. When finished turn them *clockwise to secure and seal* the 1400 from the outside environment. If you don't have enough cables to obtain a snug fit you can insert a small piece of soft PVC insulation or rubber tubing to take up the extra space.

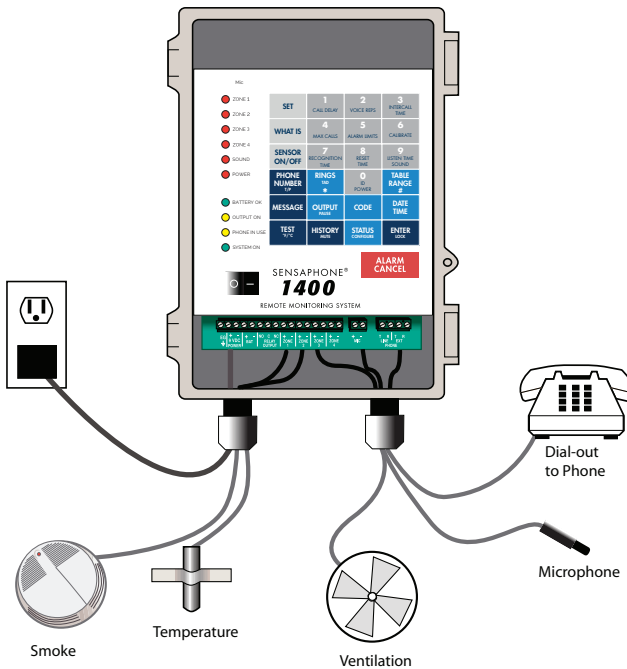

Figure 4: Typical connections from 1400

## **TURNING THE 1400 ON**

Plug the unit's transformer into a 120VAC 60Hz outlet. Toggle the power switch on to start the unit. The System-On LED should glow steadily and the unit will say "Hello." The unit will not turn on if AC power is not present, regardless of the state of the battery.

Note that when the unit is turned off, all programming is retained in non-volatile memory.

### **Backup Battery**

The Sensaphone 1400 includes a 6V 1.3AH sealed lead-acid gel-cell rechargeable battery for system back-up in the event of a power failure. The battery will provide approximately 24 hours of backup time. Actual backup time will depend upon the temperature, battery age, dialing activity, and state of the relay output. The battery is located behind the main panel.

The 1400 will automatically charge the battery whenever the power switch is turned on and the power transformer is plugged in. The battery should provide 3–5 years of service, depending on temperature and charge/discharge cycles, before needing replacement. See Appendix B for battery replacement instructions.

The 1400 also includes a 3V lithium battery to retain the date and time when main power is off. The lithium battery should provide 8-10 years of service life.

**NOTE:** Have batteries serviced by qualified service personnel only.

## **TELEPHONE LINE**

Connect the 1400's Phone jack to a standard 2-wire analog phone line. The unit dials using pulse or tone, with loop start only. The 1400 will recognize ringer frequencies from 16 to 60 Hz and will operate with all standard analog telephone systems that accept pulse or tone dialing.

Certain private telephone systems and public switching equipment may not accept the unit's dialing or may generate an unacceptable ring signal. In those cases, a dedicated line may be required for the

unit. Consult the supplier of your telephone system if you encounter problems.

**CAUTION:** Never install telephone wiring during a lightning storm. Never install telephone jacks in wet locations unless the jack is specifically designed for wet locations. Never touch uninsulated telephone wires or terminals unless the telephone line has been disconnected at the network interface. Use caution when installing or modifying telephone lines.

## Line Seizure

Line seizure gives the 1400 the ability to “seize” the telephone line when it needs to dial out. For example, if an emergency occurs which puts the 1400 in alarm mode, the unit will be able to dial out even if a telephone has been left off the hook. To the right of the LINE terminals is another set of terminals labeled EXT. These terminals can be used to share the line with other devices (telephone, fax machine, modem) and to give the 1400 priority in the event of an emergency. To make use of this feature you must have all the extension devices originate from the EXT terminals. Whenever the unit must make an alarm phone call, the unit will disconnect any current phone calls and seize the line for its own use. The unit will continue to seize the line until the alarm has been acknowledged. To ease installation, an optional accessory is available (FGD-0060 Line Seizure Kit) which provides an RJ31x modular wall jack, cable, and wiring instructions.

**NOTE:** The Line Seizure Kit is *not* required for the 1400 seizure capability to function correctly. The Kit allows the disconnection of the 1400 system from the telephone line while ensuring continued telephone operation—useful if the 1400 is, for instance, temporarily removed for service.

## WIRING SENSORS AND TRANSDUCERS

The 1400 Zones are compatible with NO/NC dry contacts, 2.8K and 10K thermistors, and 4–20mA transducers. To prevent an alarm from occurring while wiring the sensors, it is recommended that the zone alarm be disabled [SENSOR ON/OFF] + [Zone #1–4]. After wiring all of your sensors you will need to configure the zones

using the [SET] + [CONFIGURE] command. *See Chapter Four for more information on Disabling Zone alarms and Configuring Zones.*

Recommended sequence for adding a new sensor:

1. Disable the Zone's alarm.
2. Wire up the sensor.
3. Configure the Zone.
4. Enable the Zone.

**NOTE:** If a false alarm occurs while wiring a sensor, you can quickly acknowledge it by pressing the [ALARM/CANCEL] key. See Chapter Five for more information on User Acknowledgment Codes.

**Temperature:** The unit will accept 2.8K or 10K thermistors. These should be wired to a Zone terminal and the adjacent ground terminal. For recommended thermistors check the accessory list or thermistor data in the appendices. Thermistor temperature range:

2.8K: -109°F to 115°F (-85°C to 57°)

10K: -87°F to 168°F (-66°C to 76°C)

**Dry Contacts:** Only contacts which have no voltage or current applied may be used. Connect the contact to a Zone terminal and an adjacent ground terminal. Do NOT try to monitor a contact that switches 120VAC. This will permanently damage the unit.

**4–20mA:** A 4–20mA transducer requires you to have an external DC power supply for the transducer. Connect the positive wire of your transducer to the positive terminal of your DC power supply. Connect the negative terminal of the transducer to a Zone terminal on the Sensaphone 1400. Connect the negative terminal from your power supply to the adjacent ground terminal on the 1400.

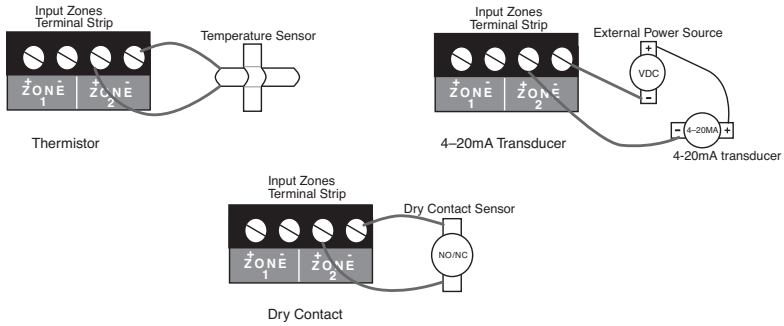

Figure 5: Different Sensor Types connected to the Terminal Block

## External Microphone

An (optional) external microphone may be connected to the MIC terminals to allow remote listen-in capabilities and high sound level detection. (**NOTE:** The built-in microphone is for message recording only.) An external microphone with a 25' cable may be ordered from your Sensaphone supplier: Part number FGD-0057. The microphone connects to the terminals labeled MIC. Be sure to observe proper polarity when connecting the microphone: Red wire to + and Black wire to -. See Chapter Five for information on programming the Listen-in Time, High Sound Alarm Recognition Time, and Sound Level Sensitivity (calibration).

## Wiring Recommendations

The 1400 will work fine in indoor environments using unshielded cable. When wiring will be subject to long lengths (>250') or if run outdoors, it is highly recommended that shielded cable be used and that the shield be connected to an earth ground. Also, be sure to use the appropriate gauge wire based on the distance and sensor type. See chart below:

<u>Wire Gauge</u>	<u>Thermistor</u>	<u>NO/NC Contact &amp; 4-20mA</u>
#24	250'	1000'
#22	500'	2000'
#20	1000'	4000'

When preparing wire for connection to the terminal blocks, strip  $\frac{1}{4}$ " of insulation from the conductor (see figure below).



Figure 6: Wire stripped for connection

## LED INDICATORS

The LEDs provide on-site alarm and status information. Listed below are descriptions of how the LEDs work.

Zones 1–4, Power and Sound:

LED Off: Zone OK

LED Blinking Fast: Alarm condition exists but recognition time has not been met

LED Blinking Slowly: Unacknowledged alarm exists

LED On: Acknowledged alarm exists

Battery:

LED On: Battery OK

LED Blinking: Battery condition low

LED Off: No battery/critically low battery condition

Output On:

LED On: Output relay on

LED Off : Output relay off

Phone-In-Use:

LED On: Unit is communicating on the phone line

LED Off: Unit is not using the phone line

System-On:

LED On: System power on

LED Off : System power off

## CHAPTER 3: QUICK START GUIDE

This section presents a brief guide and some helpful hints for first-time users of the 1400. Follow the instructions for installation before attempting to program the unit.

### HOW THE KEYPAD COMMANDS WORK

The 1400 uses simple keypad commands to program and check all pertinent parameters. All of the keypad commands begin with either the SET, WHAT IS, or SENSOR ON/OFF keys. The SET key is used to program parameters. When performing a programming sequence, the command will typically require the SET key followed by the parameter to be programmed, followed by a value, and then the ENTER key at the end. For example, to program the Call Delay you would press [SET] + [CALL DELAY] + [value] + [ENTER]. To check your programming, you would press the WHAT IS key followed by the parameter (in this case, [WHAT IS] + [CALL DELAY]).

The SENSOR ON/OFF key is generally used to enable and disable functions or to toggle a function on and off. For example, to disable a Zone you would press [SENSOR ON/OFF] + [Zone #] or to turn the speaker Mute on you would press [SENSOR ON/OFF] + [HISTORY/MUTE].

### ABORTING A COMMAND

If you are in the middle of a command and you make a mistake, you can abort the command by either pressing the ALARM CANCEL key or by simply waiting for the command to time out (typically 30 seconds). When you abort a command, the unit will say “Error 1” to indicate that the command has not been executed successfully.

### ERROR MESSAGES

When programming parameters in the 1400 you may get an error message if you inadvertently enter an incorrect value. If the unit says “Error 1,” it means that you entered a value that is out of range or have aborted the command. If Remote Programming Security

Code is enabled (*see Chapter Five*), and you enter the incorrect security code, the unit will answer with “Error 2” and offer you a second chance to enter the correct code.

## ACKNOWLEDGING A FALSE ALARM

While programming the unit you may inadvertently set off an alarm. Once an alarm occurs, the unit will start its alarm processing routine, which will prevent you from performing any other keypad function until the alarm is acknowledged. To acknowledge an alarm and stop the unit from making any phone calls, press [ALARM CANCEL]. This will acknowledge the alarm (*assuming that you have not entered any custom acknowledgment codes*). If you have entered one or more custom acknowledgment codes, then enter the code as required.

## RECOMMENDED PROGRAMMING STEPS

Listed below are the basic programming steps to get you up and running. The chapters that follow provide detailed programming instructions as well as additional options to customize the operation of your 1400.

Parameter	Chapter #
1. Set the Date & Time	5
2. Configure Zones	4
3. Set Alarm Limits	4
4. Record Zone voice messages	5
5. Record ID voice message	5
6. Set ID number	5
7. Set dialout telephone numbers	5

## CHAPTER 4: ZONE PROGRAMMING

This chapter explains the keyboard commands for the monitoring functions of the Sensaphone 1400. This includes:

- Configure Zone Type
- Enable/Disable Zones
- Temperature Scale
- Table Range for 4-20mA sensors
- Alarm Recognition Time
- Alarm Limits
- Zone Calibration
- AC Power Monitoring Enable/Disable
- AC Power Recognition Time
- Sound Level Monitoring Enable/Disable
- Sound Level Recognition Time
- Sound Level Calibration

### AUTOMATIC ZONE CONFIGURATION

The 1400 is compatible with normally open, normally closed, 2.8K thermistor (temperature), 10K thermistor (temperature), and 4-20mA type sensors. All of the Zones are configured simultaneously by keying in a simple key sequence after connecting all of your sensors. Make sure all sensors are in their normal state. All 4–20mA transducers should be powered on.

**NOTE:** New temperature sensors will default configure to 2.8K. If you are connecting any 10K sensors to the 1400, these **must** be configured manually. Any sensor that was previously configured as either 2.8K or 10K will maintain proper thermistor type. (*See the Manual Configuration section*)

1. Press the SET key.



SET

2. Press the CONFIGURE key.



The 1400 will prompt, “Enter 0 for automatic configuration, enter zone number for manual configuration.” If you press “0”, the 1400 will scan each Zone input and determine the input type.

The Zones are now considered normal. If a *normally closed* Zone becomes open, an alarm will occur. If a *normally open* Zone becomes closed, an alarm will occur.

## MANUAL ZONE CONFIGURATION

If you would like to program the Zone type (NO, NC, temperature, 4–20mA) without going through the automatic process that scans all Zones, this command will allow you to configure a single Zone. This command is useful if you have alarms on other channels and cannot use the automatic configuration process, or if you wish to configure the Zone type without actually connecting the sensor.

**NOTE:** You **MUST** use manual configuration for any zone connecting to a 10K temperature sensor.

1. Press the SET key.



2. Press the CONFIGURE key.



The 1400 will prompt, “Enter 0 for automatic configuration, enter zone number for manual configuration.”

3. Press the corresponding Zone key (1–4).

<b>1</b> CALL DELAY	<b>2</b> VOICE REPS	<b>3</b> INTERCALL TIME
<b>4</b> MAX CALLS		

The 1400 will say “Enter Mode.”

4. Press the key which corresponds to the type of Zone according to the table below:

- 1: NO Dry Contact
- 2: NC Dry Contact
- 3: 2.8K Thermistor (temperature sensor)
- 4: 10K Thermistor (temperature sensor)
- 5: 4–20mA

5. Press ENTER.



The 1400 will recite the programmed Zone input configuration.

## ENABLE/DISABLE ZONE ALARMS

This function allows you to enable or disable a Zone (1-4) for dialout during an alarm. An enabled Zone will respond to an alarm and allow dialout. A disabled Zone will not initiate a dialout, but it will still be included in the status report, preceded by the word “disabled.” This command is useful while you are wiring your Zones or at any other time you would like the alarms to be ignored. The default setting for all Zones is enabled (*on*).

1. Press the SENSOR ON/OFF key.

**SENSOR  
ON/OFF**

2. Press the corresponding number key (1–4) of the Zone you want to enable/disable. 1400 will say “Zone (1–4) Alarm On/Off” to indicate enabled or disabled respectively.

<b>1</b> CALL DELAY	<b>2</b> VOICE REPS	<b>3</b> INTERCALL TIME
<b>4</b> MAX CALLS		

3. Repeat key sequence to change.

## ENABLE/DISABLE SOUND LEVEL ALARM

This function allows you to enable or disable the sound alarm for dialout. When enabled, a high sound level at the remote microphone (optional)—*that meets the programmed recognition time and level*—will trip a sound alarm and the unit will dial out. Disabling sound will prevent a sound alarm dialout. The default setting is enabled (*on*).

1. Press the SENSOR ON/OFF key.

**SENSOR  
ON/OFF**

2. Press the Sound Alarm key (9). 1400 will say “Sound Alarm

On/Off” to indicate enabled or disabled respectively.



3. Repeat the steps to change.

## ENABLE/DISABLE POWER

This function allows you to enable or disable AC power failure monitoring (0). Enabled AC power monitoring will respond to an alarm and allow dialout. Disabled AC power monitoring will not initiate a dialout alarm. The default setting is enabled (*on*).

1. Press the SENSOR ON/OFF key.



2. Press the power key (0) to enable/disable. 1400 will say “Power Alarm On/Off” to indicate enabled/disabled.



3. Repeat the steps to change.

## CONFIGURE TEMPERATURE SCALE

The 1400 can read temperature in degrees Fahrenheit or Celsius. The default is degrees Fahrenheit.



2. Press the F/C key.



The 1400 will say “degrees Fahrenheit” or “degrees Celsius” to indicate the current setting. Repeat the key sequence to change.

## CONFIGURE TABLE RANGE FOR 4–20mA SENSORS

The 1400 allows you to create a unique linear table for each 4–20mA sensor. The Table Low (4mA) and Table High (20mA) values are used to define the lower and upper range of your 4–20mA sensor. For example, suppose you are using a 4–20mA transducer to measure the depth of water in a 15 foot well. Simply enter a Table Low value of 0 and a Table High value of 15 and the 1400 will scale the Zone to read between 0 and 15. The low and high table range can be set from -10,000 to +10,000 [Defaults: low=0, high=100]. To make a value negative, precede the value with the [RINGS/TAD/\*] key.

1. Press the SET key.



2. Press the TABLE RANGE key. 1400 will say “Enter Zone Number.”



3. Press the corresponding Zone number (1–4). 1400 will say “Enter Low Number.”

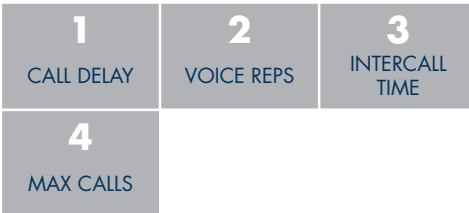

4. Using the number keys, enter the Table Low value, then press ENTER.

<b>1</b> CALL DELAY	<b>2</b> VOICE REPS	<b>3</b> INTERCALL TIME
<b>4</b> MAX CALLS	<b>5</b> ALARM LIMITS	<b>6</b> CALIBRATE
<b>7</b> RECOGNITION TIME	<b>8</b> RESET TIME	<b>9</b> LISTEN TIME SOUND
<b>RINGS</b> TAD *	<b>0</b> ID POWER	



The 1400 will say “Enter High Number.”

- Using the number keys, enter the Table High value and press ENTER.

<b>1</b> CALL DELAY	<b>2</b> VOICE REPS	<b>3</b> INTERCALL TIME
<b>4</b> MAX CALLS	<b>5</b> ALARM LIMITS	<b>6</b> CALIBRATE
<b>7</b> RECOGNITION TIME	<b>8</b> RESET TIME	<b>9</b> LISTEN TIME SOUND
<b>RINGS</b> TAD *	<b>0</b> ID POWER	



The 1400 will say “OK.”

- Press the WHAT IS key.



- Press the TABLE RANGE key. 1400 will say “Enter Zone Number.”



- Press the corresponding Zone number (1–4).

<b>1</b> CALL DELAY	<b>2</b> VOICE REPS	<b>3</b> INTERCALL TIME
<b>4</b> MAX CALLS		

The 1400 will say “Low” and speak the low table value, then it will say “High” and speak the high table value.

## ALARM RECOGNITION TIME

The Alarm Recognition Time is the length of time an alert condition must be present before a valid alarm exists and dial-out is activated. If a condition exists and then clears within the recognition time, it is not considered an alarm. This is useful to prevent nuisance dialouts for momentary alarm conditions or on self-correcting equipment. Each Zone can be programmed with a different recognition time, including Power Alarms and Sound Level Alarms. The default recognition time is 3 seconds for *Zones*, 5 minutes for *Power*, and 8 seconds for *Sound* level. You may program the recognition time for Zone and Power Alarms from 0 seconds up to 540 minutes. Sound Level Alarms may be programmed from 5 to 60 seconds.

**NOTE:** When the main power fails, the 1400 will announce out loud “Power is OFF” every 15 seconds. It will do this regardless of the programmed recognition time. As a result, when the programmed recognition time is finally met, the unit will dial immediately and not wait the programmed Call Delay time. The Power Alarm is the *only* one treated in this fashion.

1. Press the SET key.



2. Press the REC TIME key. 1400 will say “Enter Zone Number.”



3. Press the corresponding Zone key (1–4), Power(0), or Sound(9).

1 CALL DELAY	2 VOICE REPS	3 INTERCALL TIME
4 MAX CALLS	5 ALARM LIMITS	6 CALIBRATE
7 RECOGNITION TIME	8 RESET TIME	9 LISTEN TIME SOUND
	0 ID POWER	

The 1400 will say “Enter minutes.”

4. Using the number keys, enter minutes. Then press ENTER.

1 CALL DELAY	2 VOICE REPS	3 INTERCALL TIME
4 MAX CALLS	5 ALARM LIMITS	6 CALIBRATE
7 RECOGNITION TIME	8 RESET TIME	9 LISTEN TIME SOUND
	0 ID POWER	



The 1400 will say “OK, enter seconds.”

5. Using the number keys, enter seconds. Then press ENTER.

1 CALL DELAY	2 VOICE REPS	3 INTERCALL TIME
4 MAX CALLS	5 ALARM LIMITS	6 CALIBRATE
7 RECOGNITION TIME	8 RESET TIME	9 LISTEN TIME SOUND
	0 ID POWER	



1400 will say “OK.”

1. Press the WHAT IS key.



2. Press the REC TIME key.



1400 will say “Enter Zone Number.”

3. Press the corresponding Zone key (1–4), Power(0), or Sound (9).

1 CALL DELAY	2 VOICE REPS	3 INTERCALL TIME
4 MAX CALLS	5 ALARM LIMITS	6 CALIBRATE
7 RECOGNITION TIME	8 RESET TIME	9 LISTEN TIME SOUND
0 ID POWER		

The 1400 will recite the programmed recognition time for that Zone.

## ALARM LIMITS

The Alarm Limits determine the level at which a temperature or 4–20mA Zone has reached the alarm threshold. The input value must exceed the Alarm Limit to trip an alarm. Each Zone has a programmable Low and High Alarm Limit. The default settings are Low Limit=0 and High Limit=100. The range of programming for 2.8K thermistors is -109° to 115°F (-85° to 57°C). The range of programming for 10K thermistors is -87° to 168°F (-66° to 76°C). For zones configured as 4–20mA, the range of programming is -10,000 to 10,000. To make a value negative, precede the value with the [RINGS/TAD/\*]key.

Only Zones configured as temperature or 4–20mA can have Alarm Limits programmed.

1. Press the SET key.



2. Press the ALARM LIMITS key.



The 1400 will say “Enter Zone Number.”

3. Press the corresponding Zone key (1–4).



The 1400 will say “Enter Low Alarm Limit.”

4. Using the number keys, enter a value. Then press ENTER.



The 1400 will say “Enter High Alarm Limit.”

5. Using the number keys, enter a value. Then press ENTER.

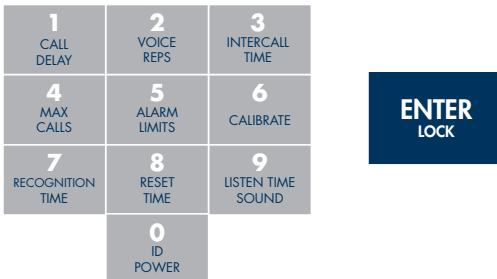

To check the alarm limits:

1. Press the WHAT IS key.



2. Press the ALARM LIMITS key. 1400 will say “Enter Zone Number.”



3. Press the corresponding Zone key (1–4). 1400 will say the programmed value.



## RESET TIME

The Reset Time allows your Sensaphone to reset the dialing sequence if an alarm continues to exist well after it has been acknowledged. For example, suppose the Reset Time for Zone 1 is programmed for 2 hours. If an alarm occurs on Zone 1 at 6PM and is acknowledged at 6:15PM and the alarm condition is never corrected, then at 8:15PM (2 hours later) the Sensaphone will “reset” the alarm and begin the notification process all over again. This feature should be used for all critical monitoring applications where a prolonged alarm condition could cause catastrophic results.

The Reset Time can be programmed between 30 and 1440 minutes for each zone. The default setting is 0 minutes - which disables the feature. The reset time is defined as the time allowed for an acknowledged alarm’s fault condition to be corrected before the alarm resets and begins the message delivery process all over again.

The Reset Time must be programmed individually for each Zone, including the Power and Sound alarm.

1. Press the SET key.



2. Press the RESET TIME key.



The 1400 will say “Enter Zone Number.”

3. Press the corresponding Zone key (1-4), Power (0), or Sound (9).



The 1400 will say “Enter minutes.”

4. Using the number keys, enter minutes. Then press ENTER.



The 1400 will say “OK.”

To check the programmed RESET TIME:

1. Press the WHAT IS key.



2. Press the RESET TIME key.



The 1400 will say “Enter Zone Number.”

3. Press the corresponding Zone key (1-4), Power (0), or Sound (9).

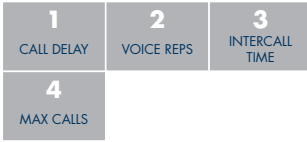

The 1400 will recite the programmed Reset Time for that Zone. If the Reset Time is set to 0 minutes the 1800 will say “Disabled”.

## ZONE CALIBRATION

Due to tolerance variations or other factors, you may need to program an offset to calibrate the sensor. The offset can range from -15 to +15 for Zones configured as temperature, and -100 to +100 for Zones configured as 4–20mA. Setting a positive number will add that number to the Zone reading. Setting a negative number will subtract the programmed value from the Zone reading. For instance, if a temperature sensor consistently read two degrees high, you could use the calibration feature to adjust that temperature down two degrees. To make a value negative, precede the value with the [RINGS/TAD/\*] Key.

1. Press the SET key.



2. Press the CALIBRATE key.



The 1400 will say “Enter Zone Number.”

3. Press the corresponding Zone key (1–4).

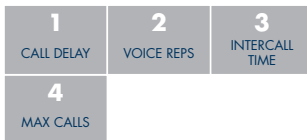

The 1400 will say “Enter Number.”

4. Enter the number. Then press ENTER.



The 1400 will say “OK.”

1. Press the WHAT IS key.



2. Press the CALIBRATE key. 1400 will say “Enter Zone Number.”



3. Press the corresponding Zone key (1–4).

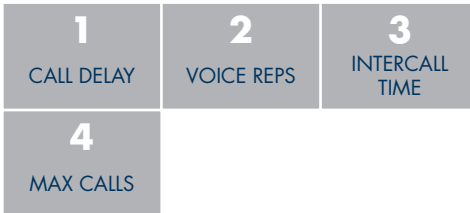

The 1400 will recite the programmed calibration.

## SOUND LEVEL CALIBRATION

This feature allows you to program the level of sound that will cause the 1400 to respond to an alarm and dial out. **NOTE:** This applies *only* to the (optional) external microphone. It may be useful to desensitize the 1400 to sound if installed in an area with a relatively high noise level, or where a loud noise occurs frequently

but is not associated with an alarm. In some applications, it may be desirable to increase sound sensitivity to low sound levels. The sensitivity setting (calibration) for Sound Alarm monitoring ranges from 1 to 160. A value of 1 makes the microphone the MOST sensitive to changes in sound. The value 160 makes the microphone the LEAST sensitive to sound. The default value is 32.

1. Press the SET key.



2. Press the CALIBRATE key.



The 1400 will say, “Enter Zone Number.”

3. Press the SOUND key.



The 1400 responds: “Enter number.”

4. Using the number keys, enter a value for sound calibration and press ENTER.

1 CALL DELAY	2 VOICE REPS	3 INTERCALL TIME
4 MAX CALLS	5 ALARM LIMITS	6 CALIBRATE
7 RECOGNITION TIME	8 RESET TIME	9 LISTEN TIME SOUND
0 ID POWER		



The 1400 will say, “OK.”

1. Press the WHAT IS key.



2. Press the CALIBRATE key. 1400 will say “Enter Zone

Number.”



3. Press the SOUND key.



The 1400 will recite the programmed sound sensitivity level.

## DESIGNATING A ZONE AS UNUSED

This feature allows you to mark selected Zones, Power, or Sound as unused, which will prohibit them from going into alarm and will also leave them out of the status report. Note that programming for the selected Zone will be preserved when the Zone is marked as “unused” and will not be reconfigured if automatic Zone configuration is activated.

If the sensor is configured as *not used*, the unit will respond “Error the zone is off”. Refer to section 5.13 to designate as used.

1. Press the SENSOR ON/OFF key.



2. Press the SET key.



The 1400 will say “Enter Zone Number.”

3. Press the corresponding number of the Zone you wish to mark as unused.

1 CALL DELAY	2 VOICE REPS	3 INTERCALL TIME
4 MAX CALLS	5 ALARM LIMITS	6 CALIBRATE
7 RECOGNITION TIME	8 RESET TIME	9 LISTEN TIME SOUND
	0 ID POWER	

The 1400 will respond by saying Zone 1–4, Power, or Sound “Off/On.” Repeat the key sequence to place the Zone back in use.

## EXIT DELAY

The Exit Delay feature is useful when you are using your 1400 for security monitoring. This feature allows you to exit a building without tripping a security alarm. When tripping an alarm is unavoidable, yet a true alert condition has not actually occurred, the alarm response—including dial-out—can be temporarily suppressed.

The 1400 is able to suppress and then reset its dial-out function automatically through use of the Status Report. This is especially convenient when an alert condition is created upon exiting a monitored door, and there is no way to cancel from the local keypad.

**Note:** The Exit Delay feature applies only to Zones configured as NO/NC.

**Example:** You are planning to exit through a monitored door. Prior to exiting, you initiate a Status Report recitation at the 1400 keypad by pressing [WHAT IS], followed by [STATUS], (key sequence shown below). This allows you the duration of the status report to exit without activating the 1400’s programmed response to an alarm. At the conclusion of the status report, normal alarm response is reactivated.

1. Press WHAT IS.

A rectangular button with a light gray background and the text "WHAT IS" in bold, dark blue capital letters.

2. Press STATUS.

A rectangular button with a blue background and the text "STATUS" in bold, white capital letters, with "CONFIGURE" in smaller, white capital letters below it.

The 1400 recites the full Status Report; during this time, you are able to exit the monitored area without tripping an alarm.

## TEMPERATURE-ONLY STATUS REPORT

You can receive a limited status report that only includes inputs configured as temperature. This can be useful when you don't care to listen to the entire status report.

1. Press the WHAT IS key

A rectangular button with a light gray background and the text "WHAT IS" in bold, dark blue capital letters.

2. Press the TEST key.

A rectangular button with a dark blue background and the text "TEST" in bold, white capital letters, with "°F/°C" in smaller white text below it.

## **CHAPTER 5: COMMUNICATION PROGRAMMING**

This chapter explains the keyboard commands for programming the communications functions of the 400. This includes programming, interrogating and/or resetting of:

- Date and Time
- Voice Messages
- ID Number
- Alarm Dial-out Telephone Numbers
- Special Dialing Options
- Dial-out Test Mode
- Tone or Pulse Dialing
- Rings Until Answer
- Call Delay Time
- Intercall Time
- Call Progress
- Voice Repetitions
- Maximum Number of Calls
- Telephone Answering Device Compatibility
- Listen-in Time
- Programming Security Code
- Speaker Mute
- Callback Acknowledgment

## DATE and TIME

The 1400 has an internal clock/calendar that is used to time-stamp events and maintain alarm history. To program the date and time:

1. Press SET, followed by the DATE/TIME key.



2. The unit will say “Enter the date.” Enter the date in month/day/year (mm/dd/yy) format using two digits for each. For example, if the date was January 7, 2017 you would enter 010717, then press ENTER.



3. Next, the unit will say “OK, enter the time.” Enter the time in 24-hour format (e.g. 3:00PM = 15:00) using hours/minutes (hh/mm) format. For example, if the time was 1:30PM you would enter 1330, then press ENTER.



4. To check the date and time press WHAT IS, followed by DATE/TIME. The unit will announce the date and time.



**NOTE:** The internal clock is powered by an onboard lithium battery which should provide 8–10 years of service life.

To program only the Date or only the Time, you can simply press the ENTER key when prompted and the unit will keep its current value. For example, to program a new TIME but keep the current DATE, press [ENTER] when prompted for the Date. The unit will keep the current setting and then prompt you to enter the new Time.

## VOICE MESSAGES

The 1400's digital speech recording feature allows you to record custom messages for each of the four Zones and an ID Message. This means that when the 1400 calls you during an alarm, you will hear a personalized Voice Message identifying the unit and telling you exactly what alarm condition exists. You can record a separate message for each of the four Zones. The message can run a maximum of 5 seconds. The ID Message can be a maximum of 8 seconds. You can shorten the message length by pressing the ENTER key after reciting the message.

The **ID Message** is used to identify the unit. This could be a particular building name, its location (address or city), or some other identifier.

### To program the ID Message:

1. Locate the condenser mic.

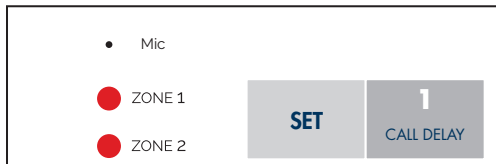

2. Press the SET key.



3. Press the MESSAGE key. The 1400 will say "Enter Message Number."



4. Press the ID key (number 0 key).



5. When the unit beeps, begin speaking your message into the microphone. The unit will say "OK," when the recording time has elapsed; then it will play back your recorded message.

## To play back the ID Message:

1. Press the WHAT IS key.



2. Press the MESSAGE key.



3. Press the ID key (number 0 key).



The 1400 will play back your recorded message.

The **Zone Messages** are used to identify the device or condition being monitored such as temperature, humidity, equipment alarms, security alarms, etc.

## To program the Voice Message for a Zone:

1. Locate the condenser mic.

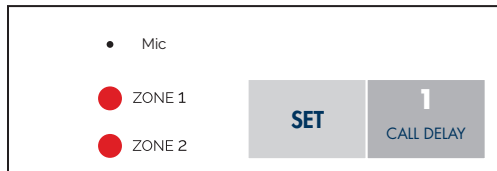

2. Press the SET key.



3. Press the MESSAGE key. The 1400 will say, "Enter Message Number."



4. Press the number key for the corresponding Zone.



5. When the unit beeps, begin speaking your message into the microphone. The unit will say “OK,” when the recording time has elapsed; then it will play back your recorded message.

### To play back the message for a Zone:

1. Press the WHAT IS key.



2. Press the MESSAGE key.



3. Press the corresponding Zone number key.



The 1400 will play back your recorded message.

### To erase a Zone or ID message:

1. Press the SENSOR ON/OFF key.



2. Press the MESSAGE key.



The 1400 will say “Enter message number.”

3. Press the Zone Number or ID key.

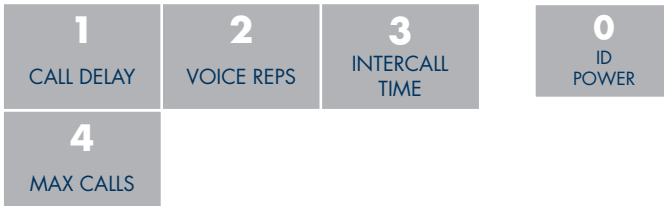

The 1400 will say, “Message erased.”

## ID NUMBER

The ID Number is the identification number of the 1400. This number is typically the telephone number where the unit is installed, or it may be designated using any number that best suits your application. The purpose of the ID Number is to immediately provide the source of any alarm, especially when using multiple 1400 units in a complex monitoring system. The ID number is announced during voice alarm messages and displayed on pagers. The ID Number can be up to 16 digits long.

When the 1400 is called from a remote location, it always begins its message with the identification number: “Hello, this is (ID Number).” If no ID Number is programmed, the unit will say, “Hello, this is Sensaphone 1400.”

### To program the ID Number:

1. Press the SET key.



2. Press the ID key (number 0 key).



3. The unit will say “Enter ID number.” Using the number keys, enter the unit’s phone number, then press ENTER.

<b>1</b> CALL DELAY	<b>2</b> VOICE REPS	<b>3</b> INTERCALL TIME
<b>4</b> MAX CALLS	<b>5</b> ALARM LIMITS	<b>6</b> CALIBRATE
<b>7</b> RECOGNITION TIME	<b>8</b> RESET TIME	<b>9</b> LISTEN TIME SOUND
	<b>0</b> ID POWER	



If the number was accepted, the 1400 will say “OK.”

## To play back the ID Number:

1. Press the WHAT IS key.



2. Press the ID key (number 0 key).

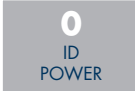

The 1400 will recite the ID Number.

## To erase the ID Number:

1. Press the SET key.



2. Press the ID key (number 0 key).



The 1400 will say “Enter ID Number.”

3. Press the ENTER key.



The 1400 will say “ID Number erased.”

## ALARM DIAL-OUT TELEPHONE NUMBERS

The Sensaphone 1400 will dial up to eight 48-digit phone numbers to report alarm conditions. These are the numbers that will be called during an alarm dial-out. The unit can deliver an alarm message via voice telephone call or numeric page. The telephone numbers are dialed sequentially 1 through 8. Therefore, program the first number you want called as Phone #1, the second one as Phone #2, and so on. A pause, pound or asterisk can be added to the phone number to access different phone and beeper systems (see special dialing options). Once the alarm is acknowledged, all dial-out stops.

### Voice Dialout

When 1400 calls in Voice mode it will announce the ID Message and the alarm message. Afterward it will ask for the acknowledgement code. If a correct code is entered, the unit will stop dialout. If the wrong code is entered it will hang up and continue dialing the next number.

### To program a VOICE dial-out telephone number:

1. Press the SET key.



2. Press the PHONE NUMBER key. The 1400 will say “Enter Number.”



3. Select which Phone number to program. Press any unassigned number key (keys 1–8) to represent the new telephone number entry. 1400 will respond “Enter number.”



4. Enter the phone number using the number keys, and then press ENTER. Be sure to enter “1” + area code if required. If installed on a PBX system, be sure to enter a “9” if required.

<b>1</b> CALL DELAY	<b>2</b> VOICE REPS	<b>3</b> INTERCALL TIME
<b>4</b> MAX CALLS	<b>5</b> ALARM LIMITS	<b>6</b> CALIBRATE
<b>7</b> RECOGNITION TIME	<b>8</b> RESET TIME	<b>9</b> LISTEN TIME SOUND
<b>0</b> ID POWER		

**ENTER**  
LOCK

1400 will say “OK.”

### To play back a programmed dial-out telephone number:

1. Press the WHAT IS key



2. Press the PHONE NUMBER key. 1400 will say “Enter Number.”



3. Select an assigned Phone number (keys 1–8).

<b>1</b> CALL DELAY	<b>2</b> VOICE REPS	<b>3</b> INTERCALL TIME
<b>4</b> MAX CALLS	<b>5</b> ALARM LIMITS	<b>6</b> CALIBRATE
<b>7</b> RECOGNITION TIME	<b>8</b> RESET TIME	

The 1400 will recite the number programmed. If there is no number programmed, 1400 will say “No number.”

### To erase a dial-out telephone number:

1. Press the SET key.



2. Press the PHONE NUMBER key. The 1400 will say “Enter Number.”



3. Select an assigned Phone Number (keys 1–8), and press ENTER.



The 1400 will say “Number (1–8) erased.”

## Numeric Pager Dialout

When programming the 1400 to dial a Numeric pager there are two methods that can be used: **Automatic** mode and **Manual** mode.

The only difference is that in Automatic mode the 1400 will automatically try to sense when the call has been answered and then send the ID Number and zone numbers. In some instances, the automatic answer detection and timing from the 1400 is incompatible with the paging service, and the Manual mode must be used.

**NOTE:** If your phone system requires you to dial a ‘9’ followed by a pause to get an outside line, you *must* use **Manual** mode and insert *pauses* at the end of the number.

When the 1400 calls your Numeric Pager it will leave the programmed ID Number along with the Zone number that is in alarm. If it’s reporting a Power alarm, it will send the ID Number followed by the number “0”; if it’s reporting a Sound alarm, the 1400 will send the ID Number followed by the number “9”. To acknowledge the alarm you will have to call the unit back and enter an acknowledgement code, otherwise the unit will continue dialing the remaining numbers.

## To program a NUMERIC PAGER using AUTOMATIC Mode:

1. Press the SET key



2. Press the PHONE NUMBER key. 1400 will say “Enter Number.”



3. Select which Phone number to program. Press any unassigned number key (keys 1–8) to represent the new telephone number entry. 1400 will respond “Enter number.”

<b>1</b> CALL DELAY	<b>2</b> VOICE REPS	<b>3</b> INTERCALL TIME
<b>4</b> MAX CALLS	<b>5</b> ALARM LIMITS	<b>6</b> CALIBRATE
<b>7</b> RECOGNITION TIME	<b>8</b> RESET TIME	

4. Press CODE 1 (This tells 1400 this is a Numeric Pager call).



The 1400 will say “Pager.”

5. Enter the pager number using the number keys. Then press ENTER.

<b>1</b> CALL DELAY	<b>2</b> VOICE REPS	<b>3</b> INTERCALL TIME
<b>4</b> MAX CALLS	<b>5</b> ALARM LIMITS	<b>6</b> CALIBRATE
<b>7</b> RECOGNITION TIME	<b>8</b> RESET TIME	<b>9</b> LISTEN TIME SOUND
	<b>0</b> ID POWER	



The 1400 will say “OK.”

## To program a NUMERIC PAGER using the MANUAL Mode:

1. Press the SET key



2. Press the PHONE NUMBER key. 1400 will say “Enter Number.”



3. Select which Phone number to program. Press any unassigned number key (keys 1–8) to represent the new telephone number entry. 1400 will respond: “Enter number.”

<b>1</b> CALL DELAY	<b>2</b> VOICE REPS	<b>3</b> INTERCALL TIME
<b>4</b> MAX CALLS	<b>5</b> ALARM LIMITS	<b>6</b> CALIBRATE
<b>7</b> RECOGNITION TIME	<b>8</b> RESET TIME	

4. Press CODE 1 (This tells 1400 this is a Numeric pager call).



The 1400 will say “Pager.”

5. Enter the pager telephone number using the number keys.

<b>1</b> CALL DELAY	<b>2</b> VOICE REPS	<b>3</b> INTERCALL TIME
<b>4</b> MAX CALLS	<b>5</b> ALARM LIMITS	<b>6</b> CALIBRATE
<b>7</b> RECOGNITION TIME	<b>8</b> RESET TIME	<b>9</b> LISTEN TIME SOUND
	<b>0</b> ID POWER	

6. Press the PAUSE key twice.



**NOTE:** Depending on your pager service, you may need to insert a longer or shorter delay (additional/fewer pauses). Two pauses is the recommended starting point. Use the Dial-out Test Mode to help determine the proper number of pauses for your pager service. When it is programmed properly, you will hear the 1400 dial your pager service, then wait (based on the number of pauses) until the call has been answered, and then send another series of Touch-Tones and hang up.

7. Press the ENTER key.



### To play back a NUMERIC PAGER number:

1. Press WHAT IS



2. Press the PHONE NUMBER key



3. Select the programmed Phone Number from the number keys (keys 1–8). The 1400 will recite the type of call, “pager,” followed by the pager number assigned to that key.

1 CALL DELAY	2 VOICE REPS	3 INTERCALL TIME
4 MAX CALLS	5 ALARM LIMITS	6 CALIBRATE
7 RECOGNITION TIME	8 RESET TIME	

## SPECIAL DIALING OPTIONS

The 1400 has provisions for special dialing requirements. These including dialing a \* or #, inserting a two-second pause, or forcing the system to wait for the called party to answer. These options are typically used when: (a) the unit is connected to a PBX and must dial a prefix such as '9' or extension to reach an outside line; (b) when dialing a business and stepping through menus to reach a specific extension; or (c) when a pager service is answered by a voice menu. The special dialing commands can be inserted as part of the dialout telephone number. Valid commands are listed below.

- A # tone can be dialed by inserting the TABLE RANGE/# key in the telephone number.



- The \* tone can be dialed by inserting the RINGS/TAD/\* key in the telephone number.



- A two-second pause can be inserted in the dialout telephone number by pressing the PAUSE key.



- The 1400 can be instructed to wait for the call to be answered before dialing additional digits. This is useful if you need to call a company's main number and then dial additional digits to go to a specific extension (Example: 888-555-1200—wait for answer—227). Note that the unit will automatically wait for answer after dialing the last programmed digit. Press CODE 2 to make the unit wait for an answer, as in the example.

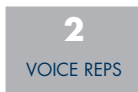

## Change to Touch-Tone Dialing

In a situation where you must use pulse dialing, pressing CODE 3 will change all following digits to Touch-Tone.



## Special Dialing Code Summary

Special Dialing Codes for the 1400 are:

Code 1: Numeric pager type

Code 2: Wait for answer

Code 3: Change to Touch-Tone

## DIAL-OUT TEST MODE

The 1400 allows you to test your telephone programming by simulating an alarm dialout to any programmed telephone number. This can be a valuable tool for insuring that your programming is correct and also for troubleshooting dialing problems. In this mode all signals on the telephone line are audible through the local speaker.

### To test a dialout phone number:

1. Press the SET key.



2. Press the TEST key.



The 1400 will say “Enter Number.”

3. Press a number key (1–8) corresponding to the phone number entry you wish to test, and press ENTER.



The 1400 will dial the number and announce the date and time for voice calls, or send its ID number for pager calls.

### To manually dial a phone number:

1. Press the SET key.



2. Press the TEST key.



The 1400 will say “Enter number.”

3. Press 0, then ENTER to enter manual dialing mode. The 1400 will go off-hook and you should hear a dial tone through the speaker. Press any number keys to dial a telephone number.



4. Press ALARM CANCEL to hang up and exit the test.



## ALARM ACKNOWLEDGMENT CODES

When the 1400 detects an alarm, it starts dialing each telephone number until it receives acknowledgment or reaches the maximum number of calls. There are two acknowledgment modes: The default, Single-User mode is for users who are not concerned with knowing who responds to and acknowledges the alarm. In this mode, the default code of “555” is used. In Single-User mode an alarm can be acknowledged by pressing the ALARM CANCEL button on the keypad, or by entering the *Acknowledgment Code* of 555 over the telephone using touch tones.

In Multiple-User mode, up to 8 custom Acknowledgment Codes can be created in order to track who acknowledges alarms. These are 5-digit custom codes, replacing the default “555.” The 5-digit Acknowledgment Code comprises the user’s entry number (1–8) plus a four-digit number. Up to eight different Acknowledgment Codes may be programmed into the unit to identify individual users in the Alarm History Log.

When the unit makes a telephone call in *Voice* mode it will prompt the user to enter an Acknowledgment Code. If this is entered correctly, the 1400 will say “Alarm Acknowledged.” When an alarm message is sent to a *pager*, the person who receives the page will have to call the unit back to acknowledge the alarm. In Single-User mode, the user must enter “555” to acknowledge the alarm. In Multiple-User mode, the user must enter his or her 5-digit Acknowledgment Code.

### To Program Multiple-User Acknowledgment Codes:

1. Press SET



2. Press CODE



The 1400 will say “Enter Code Number.”

3. Press a number (1–8) to assign the user.

<b>1</b> CALL DELAY	<b>2</b> VOICE REPS	<b>3</b> INTERCALL TIME
<b>4</b> MAX CALLS	<b>5</b> ALARM LIMITS	<b>6</b> CALIBRATE
<b>7</b> RECOGNITION TIME	<b>8</b> RESET TIME	

The 1400 will say “Enter code.”

4. Enter the additional four digits of your personal code.

The 1400 will say “OK.”

### To play back an Acknowledgment Code:

1. Press WHAT IS



2. Press CODE



3. Press an assigned number entry 1–8.

<b>1</b> CALL DELAY	<b>2</b> VOICE REPS	<b>3</b> INTERCALL TIME
<b>4</b> MAX CALLS	<b>5</b> ALARM LIMITS	<b>6</b> CALIBRATE
<b>7</b> RECOGNITION TIME	<b>8</b> RESET TIME	

The 1400 will recite the Acknowledgment Code for the selected telephone number entry.

**Note:** In default Single-User mode, the unit will announce “555” immediately after pressing the CODE key.

## To erase an Acknowledgment Code:

1. Press the SET key.



2. Press the CODE key.



The 1400 will say “Enter Code Number.”

3. Press an assigned user number, 1–8.

<b>1</b> CALL DELAY	<b>2</b> VOICE REPS	<b>3</b> INTERCALL TIME
<b>4</b> MAX CALLS	<b>5</b> ALARM LIMITS	<b>6</b> CALIBRATE
<b>7</b> RECOGNITION TIME	<b>8</b> RESET TIME	

4. Press the ENTER key.



The 1400 will say “Code [number] Erased.”

**Note:** If no User Codes are programmed, the unit automatically defaults to Single-User mode (i.e., the default code of “555”).

## ALARM HISTORY

The 1400 will retain historical information on the last 10 alarms. The information retained includes: Zone number, the time/date that the alarm occurred, and the User number that acknowledged the alarm.

### To hear the Alarm History:

1. Press the WHAT IS key.



2. Press the HISTORY key.



The unit will recite the history for the last 10 alarms. A sample report is shown below:

“Zone 1 (custom message) alarm high at 3:31PM April 8, 2017  
acknowledged by number 4”

“Zone 3 (custom message) alarm low at 2:35AM March 27, 2017  
acknowledged by number 1”

In Single-User mode, the report will state “Alarm acknowledged” for alarms acknowledged via telephone. It will state “Manual acknowledgment” for alarms acknowledged at the keypad. In Multiple-User mode, the report will state the user number that acknowledged the alarm. If the maximum number of calls have been made, the report will state “Automatic acknowledgment.”

### Deleting the Alarm History:

The Alarm History can be deleted by pressing SET, then HISTORY.



The 1400 will say “Erased.”

## **TONE OR PULSE DIALING**

The 1400 can dial out in pulse or touch-tones. All numbers will be called using the chosen dialing method. The default is TONE.

### **To program as either Tone or Pulse:**

1. Press the SENSOR ON/OFF key.

A rectangular button with a light gray background and dark blue text. The text is arranged in two lines: "SENSOR" on the top line and "ON/OFF" on the bottom line.

2. Press the PHONE NUMBER(T/P) key.

A rectangular button with a dark blue background and white text. The text is arranged in three lines: "PHONE" on the top line, "NUMBER" on the middle line, and "T/P" on the bottom line.

The unit will say “Tone” to indicate that Tone dialing is enabled, it will say “Pulse” when pulse dialing is enabled.

## RINGS UNTIL ANSWER

The Rings Until Answer is the number of rings that must occur before 1400 answers the phone. This value can be from 1 to 15. The default value is 4.

### To program Rings Until Answer:

1. Press the SET key



2. Press the RINGS key.



The 1400 will say “Enter number.”

3. Using the number keys, enter a value and press ENTER.

1 CALL DELAY	2 VOICE REPS	3 INTERCALL TIME
4 MAX CALLS	5 ALARM LIMITS	6 CALIBRATE
7 RECOGNITION TIME	8 RESET TIME	9 LISTEN TIME SOUND
0 ID POWER		



The 1400 will say “OK.”

### To play back the Rings Until Answer:

1. Press the WHAT IS key



2. Press the RINGS key.



The 1400 will recite the programmed value.

## CALL DELAY TIME

The call delay time is the length of time the 1400 will announce an alarm before it starts the dial-out sequence. This only applies to the first call. To set delay time *between* calls, see INTERCALL TIME. The default call delay time is 30 seconds. It can be programmed from 0 to 60 minutes. The purpose of Call Delay is to allow time for personnel at the 1400's installation site to respond to and cancel an alarm before dial-out begins. During this time, the unit will audibly repeat its "alarm" message and the front panel alarm LED will blink.

### To program call delay time:

1. Press the SET key.



2. Press the CALL DELAY key.



The 1400 will say "Enter minutes."

3. Enter the number of minutes using the number keys. Then press ENTER. To keep the previous setting, just press ENTER.



The 1400 will say "Enter Seconds."

- Using the number keys, enter the number of seconds, and then press ENTER. To keep the previous setting, just press ENTER.

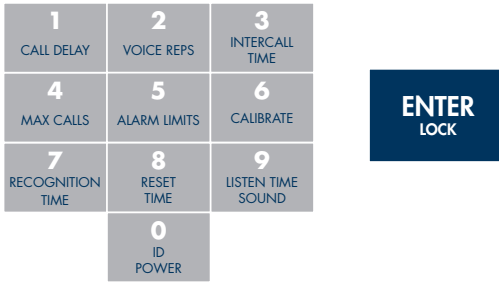

The 1400 will say “OK.”

To play back the call delay time:

- Press the WHAT IS key



- Press the CALL DELAY key



The 1400 will recite the programmed time.

## INTERCALL TIME

The Intercall Time is the programmable period of time the 1400 waits between making alarm phone calls. Intercall Time is activated ***only after alarm dial-out to the first telephone number fails to be acknowledged.*** This period can be programmed from 10 seconds to 60 minutes. The default Intercall Time is 30 seconds.

**TIP:** When the 1400 is programmed to make calls to pagers, make sure the intercall delay time is long enough to give the person carrying the pager some time to get to a phone to call the unit back.

If an incoming telephone call is received by the 1400 during the Intercall Time (in between dialing of subsequent telephone numbers to report an alarm), it will answer the incoming call and immediately report any existing alarms. The manner in which the incoming call is answered depends upon whether or not TAD is enabled or disabled (*See Telephone Answering Device (TAD) compatibility*):

If TAD is disabled (default), Rings Until Answer will be the programmed number of rings.

If TAD (Telephone Answering Device) is enabled, Rings Until Answer will be **1**.

### To program intercall time:

1. Press the SET key.



2. Press the INTERCALL TIME key.



The 1400 will say “Enter minutes.”

- Using the number keys, enter the number of minutes, and then press ENTER. To keep the previous setting, just press ENTER.



The 1400 will say “Enter seconds.”

- Using the number keys, enter the number of seconds, and press ENTER. To keep the previous setting, just press ENTER.



The 1400 will say “OK.”

### To play back the Intercall Time:

- Press the WHAT IS key



- Press the INTERCALL TIME key



The 1400 will recite the programmed time.

## CALL PROGRESS

The 1400 monitors call progress when it dials out for an alarm. If 1400 encounters a busy signal or receives no answer after ten rings, the unit hangs up, waits the programmed intercall time and then dials the next phone number. When dialing some beeper/pager services, the line may be answered before receiving a ringback. This may interfere with the call progress detection and result in a failed call to certain phone systems or beeper/pager services. If this occurs, disable call progress detection. Default setting is *Enabled*.

### To enable/disable call progress detection:

1. Press the SENSOR ON/OFF key.

A rectangular button with a light gray background. The text "SENSOR" is on the top line and "ON/OFF" is on the bottom line, both in a bold, dark blue, sans-serif font.

2. Press the STATUS/CONFIG key.

A rectangular button with a solid blue background. The text "STATUS" is on the top line and "CONFIGURE" is on the bottom line, both in a white, sans-serif font.

The 1400 will respond “Call Progress Enabled/Disabled” to indicate that call progress has been turned on or off respectively.

3. Repeat key sequence to change.

## VOICE REPETITIONS

The voice repetitions is the number of times the 1400 will recite the alarm message per phone call when it dials out. This can be programmed from 1 to 10 repetitions. The default value is 3 repetitions.

### To program the voice repetitions:

1. Press the SET key



2. Press the VOICE REPS key.

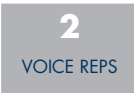

The 1400 will say, "Enter number."

3. Using the number keys, enter a value and then press ENTER.

1 CALL DELAY	2 VOICE REPS	3 INTERCALL TIME
4 MAX CALLS	5 ALARM LIMITS	6 CALIBRATE
7 RECOGNITION TIME	8 RESET TIME	9 LISTEN TIME SOUND
0 ID POWER		



The 1400 will say "OK."

### To play back the number of voice repetitions:

1. Press the WHAT IS key.



2. Press the VOICE REPS key.

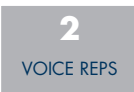

The 1400 will recite the number programmed.

## MAX CALLS

The 1400 has the ability to acknowledge itself by using the Max Calls function. The unit keeps a count of the number of phone calls it makes for a particular alarm. Once the number of calls made reaches Max Calls, the 1400 will acknowledge the alarm and stop the dialout process. The unit indicates it has reached max calls by saying “alarm acknowledged by (ID Number).” The max calls can be programmed from 0 to 255. The default is 100.

**NOTE:** If only one Phone Number is programmed, 1400 will dial a maximum of 15 times, regardless of the programmed value of max calls, as required by FCC rules.

### To program Max Calls:

1. Press the SET key.



2. Press the MAX CALLS key.

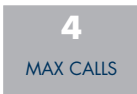

1400 will say “Enter number.”

3. Using the number keys, enter a value, then press ENTER.



The 1400 will say “OK.”

## To play back Max Calls:

1. Press the WHAT IS key.

**WHAT IS**

2. Press the MAX CALLS key

**4**

MAX CALLS

The 1400 will recite the value of max calls.

## TELEPHONE ANSWERING DEVICE (TAD) COMPATIBILITY

The 1400 can be used on the same telephone line as a telephone answering device, such as an answering machine, fax machine, or modem. This feature allows you to call in to the 1400 and bypass the answering device. Default setting is *Off [disabled]*.

### To use TAD:

1. Program the 1400's Rings Until Answer to a greater number than the rings until answer for your answering device. For example, 1400 RINGS = 5, device rings = 3.
2. Press the SENSOR ON/OFF key.

A rectangular button with a light gray background and the text "SENSOR ON/OFF" in bold, dark blue capital letters.

3. Press the TAD key.

A rectangular button with a blue background and the text "RINGS" in white capital letters at the top, "TAD" in smaller white capital letters below it, and an asterisk "\*" in white at the bottom.

The 1400 will say "TAD On." (If the 1400 says "TAD Off" repeat steps 2 and 3.)

4. Once TAD is on, allow the phone to ring once when you call the unit and then hang up. The 1400 recognizes that a call was made and activates a 30 second internal timer. This allows you 30 seconds to call the 1400 back.
5. Call back within 30 seconds. The 1400 will override the answering device on this incoming call and answer the phone on the first ring. The 1400 resets the TAD timer after one incoming call is received. If you want to call the unit again, you must repeat steps 4 and 5.

## LISTEN-IN TIME

The Listen-In Time is the amount of time you can listen to sounds at the unit's location during a status call-in. An external microphone (optional) is required to listen in to on-site sounds. The programmable range is 0 to 255 seconds. The default setting is 0 seconds (disabled).

### To program the Listen-In Time:

1. Press the SET key.



2. Press the LISTEN TIME key.



The 1400 will say “Enter seconds.”

3. Using the number keys, enter the seconds, then press ENTER.



The 1400 will say “OK.”

### To play back the Listen-in Time:

1. Press the WHAT IS key.



2. Press the LISTEN TIME key



The 1400 will recite the time programmed.

## REMOTE PROGRAMMING SECURITY CODE (LOCK)

The 1400 can be locked to prevent unauthorized call-in access to its programming. You may, however, listen to a status report without unlocking the 1400. To remotely edit programming parameters or record messages, you must call in and unlock the 1400 by entering the four-digit lock/unlock code.

If you enter the correct code, you will gain access to the 1400 to use the phone commands. If you enter the incorrect code, the 1400 will say “Error 2” and allow you a second chance to enter the correct code. If the second attempt is also wrong, the unit will say “Error 2, good-bye” and disconnect. You cannot program or change the lock code remotely.

For an explanation of how to use remote programming, see Chapter Seven.

### To set the security code:

1. Press the SET key.



2. Press the LOCK key.



The 1400 will say “Enter security code.”

3. Using the number keys, enter 4 digits, and press ENTER.

<b>1</b> CALL DELAY	<b>2</b> VOICE REPS	<b>3</b> INTERCALL TIME
<b>4</b> MAX CALLS	<b>5</b> ALARM LIMITS	<b>6</b> CALIBRATE
<b>7</b> RECOGNITION TIME	<b>8</b> RESET TIME	<b>9</b> LISTEN TIME SOUND
<b>0</b> ID POWER		



The 1400 will say “OK.”

## To play back the security code:

1. Press the WHAT IS key.



2. Press the LOCK key.



The 1400 will recite the security code.

## To remove the security code:

1. Press the SET key.



2. Press the LOCK key.



The 1400 will say “Enter security code.”

3. Press ENTER.



The 1400 will say “Security code erased.”

## **SPEAKER MUTE**

When the 1400 dials out with an alarm, it recites the alarm message over the phone and at the monitor site. The Speaker Mute command allows you to silence the 1400 at the monitor site.

### **To Mute the speaker:**

1. Press the SENSOR ON/OFF key.



2. Press the MUTE key



The 1400 will say “Mute On” to indicate that the speaker mute is on. It will say “Mute Off” to indicate when the speaker mute is off.

3. Repeat key sequence to change.

## CALLBACK ACKNOWLEDGMENT

This is an optional feature that can be enabled using the keypad (*default=disabled*). It allows an alarm to be acknowledged simply by calling the unit and letting the line ring 10 times. When this feature is enabled it will temporarily make the Rings Until Answer set to 10 when an unacknowledged alarm exists. If you receive a call via Voice or Pager and are unable to send touch-tones, you can call the unit back, let the line ring 10 times, and the unit will answer and say "...Alarm Acknowledged."

**NOTE:** If TAD is also enabled, then you must call the 1400, let it ring once, hang up, and then call the unit back within 30 seconds. The unit will answer on 1 ring and acknowledge the alarm.

### To Enable the Callback Acknowledgment Feature:

1. Press SENSOR ON/OFF.



2. Press CODE.



The 1400 will say "Callback Acknowledgment Enabled/Disabled" to indicate that Callback Acknowledgment is enabled. Repeat the key sequence to disable.

## CHAPTER 6: CONTROLLING THE OUTPUT

The 1400 includes a relay output that can be used to control a light, siren, or other device. The output is a Form-C Normally Open/ Normally Closed mechanical relay and is rated for up to 120VAC 2A. A sample wiring diagram is shown below:

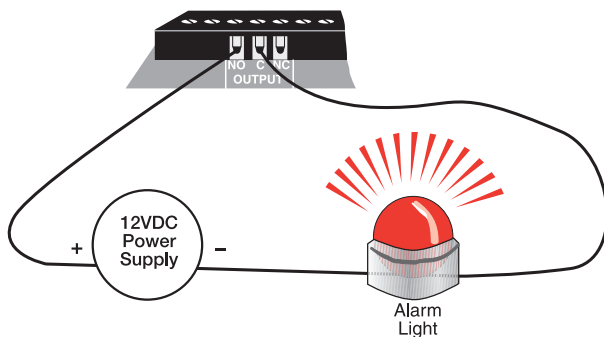

Figure 1: Relay output connected to alarm

The output can be programmed to operate in one of 7 automatic modes or it can operate in manual mode (default). The 7 *automatic* modes allow the output to automatically turn on and off based on individual alarms or any alarm. In *manual* mode the output is controlled via keypad command or remotely via touch-tone phone (See Chapter 7). A description of each mode is shown below:

### AUTOMATIC MODES

**Mode 1:** Output on when zone 1 goes into alarm. Off when alarm is acknowledged.

**Mode 2:** Output on when zone 2 goes into alarm. Off when alarm is acknowledged.

**Mode 3:** Output on when zone 3 goes into alarm. Off when alarm is acknowledged.

**Mode 4:** Output on when zone 4 goes into alarm. Off when alarm is acknowledged.

**Mode 5:** Output on when a Sound alarm occurs. Off when alarm is acknowledged.

**Mode 6:** Output on when a Power alarm occurs. Off when alarm is acknowledged.

**Mode 7:** Output on when any alarm occurs. Off when all alarms are acknowledged.

## MANUAL MODE

**Mode 0:** Output controlled manually via keypad command or touch-tone telephone.

When programmed for Manual mode, the command to switch the output is:

SENSOR ON/OFF + OUTPUT.

A rectangular button with a light gray background and dark blue text that reads "SENSOR ON/OFF".A rectangular button with a blue background and white text that reads "OUTPUT PAUSE".

The 1400 will respond “ON” or “OFF” to indicate the state of the output.

**Note:** If the 1400 says “Error,” the output is not programmed for manual mode.

### To program the Output Mode:

1. Press the SET key.

A rectangular button with a light gray background and dark blue text that reads "SET".

2. Press the OUTPUT key.

A rectangular button with a blue background and white text that reads "OUTPUT PAUSE".

The 1400 will say “Enter output mode.”

3. Using the number keys, enter a value for the output mode.

<b>1</b> CALL DELAY	<b>2</b> VOICE REPS	<b>3</b> INTERCALL TIME
<b>4</b> MAX CALLS	<b>5</b> ALARM LIMITS	<b>6</b> CALIBRATE
<b>7</b> RECOGNITION TIME	<b>8</b> RESET TIME	<b>9</b> LISTEN TIME SOUND
<b>0</b> ID POWER		

4. Press the ENTER key.



The 1400 will say “OK” and recite a description of the mode selected, such as “Automatic on Zone 1” or “Manual.” Note that when *Mode 7* is selected, the 1400 will simply say “Automatic on Alarm,” meaning that the output will automatically turn on when any alarm occurs.

### To play back the programmed Output Mode:

1. Press WHAT IS.



2. Press OUTPUT.



The 1400 will recite the programmed output mode.

## CHAPTER 7: OPERATION

After installation and programming have been completed, the Sensaphone 1400 is fully operational. This chapter explains how the 1400 operates.

### ALARM DIALOUT AND ACKNOWLEDGMENT

There are three stages to a complete alarm event: 1) Alarm Recognition, 2) Alarm Notification, 3) Acknowledgment. Note that not all alert conditions will go through each stage. For example, some may not meet the recognition time.

#### Alarm Recognition

1. The 1400 monitors four zones plus sound level and power failure. When the status of a zone changes or exceeds user-programmed limits, it causes an alert condition.
2. If the alert condition lasts long enough to meet its programmed recognition time, the alert condition becomes an alarm and the 1400 begins the alarm notification sequence.

#### Alarm Notification

The 1400 can make two types of phone calls: Voice and Numeric Pager.

#### Dialout Note: Call Progress

The 1400 monitors call progress when dialing out. If the 1400 dials out and encounters a busy signal or no answer after 10 rings, the unit hangs up, waits the programmed intercall delay time, and then dials the next phone number.

**NOTE:** Dial-tone and call-progress detection may optionally be disabled.

#### Alarm Dialout—Voice

When dialing out to a destination programmed as “voice,” the 1400 waits for the phone to be answered, then recites its user-recorded identification message, then the message identifying the zone or zones that have gone into alarm.

Below is an example of what the 1400 might say during a typical “voice” dialout:

“Hello, this is 555-2278, ‘Acme Medical Laboratory,’ Zone One, ‘Temperature in Refrigerator One,’ a high temperature alarm exists, it is now 50 degrees Fahrenheit, too high. Listen to sound for ten seconds.”

“Hello, this is 555-2278, ‘Acme Medical Laboratory,’ Zone One, ‘Temperature in Refrigerator One,’ a high temperature alarm exists, it is now 50 degrees Fahrenheit, too high. Listen to sound for ten seconds.”

“Hello, this is 555-2278, ‘Acme Medical Laboratory,’ Zone One, ‘Temperature in Refrigerator One,’ a high temperature alarm exists, it is now 50 degrees Fahrenheit, too high. Listen to sound for ten seconds.”

“Enter acknowledgment code.”

In this example, the number of Voice Message Repetitions was set to three.

**NOTE:** If the call reaches an answering machine, the message will be recorded, but the 1400 will be talking over your outgoing message, so you will probably lose part of the first alarm message repetition.

## **Alarm Dialout—Pager**

When dialing out to a destination programmed as “Numeric Pager,” the 1400 leaves its programmed ID number on the display of a numeric pager along with the zone number(s) in alarm.

**IMPORTANT:** When dialing out to a phone number programmed as “Numeric Pager,” the 1400 DOES NOT speak a voice message. It calls the pager company or service, enters the number to be displayed on the beeper, then hangs up.

## ALARM ACKNOWLEDGMENT

### Alarm Acknowledgment—Voice Dialout

Repeated below is the same example of what the 1400 might say during a typical “voice” dialout:

“Hello, this is 555-2278, ‘Acme Medical Laboratory,’ Zone One, ‘Temperature in Refrigerator One,’ a high temperature alarm exists, it is now 50 degrees Fahrenheit, too high. Listen to sound for ten seconds.”

“Hello, this is 555-2278, ‘Acme Medical Laboratory,’ Zone One, ‘Temperature in Refrigerator One,’ a high temperature alarm exists, it is now 50 degrees Fahrenheit, too high. Listen to sound for ten seconds.”

“Hello, this is 555-2278, ‘Acme Medical Laboratory,’ Zone One, ‘Temperature in Refrigerator One,’ a high temperature alarm exists, it is now 50 degrees Fahrenheit, too high. Listen to sound for ten seconds.”

“Enter acknowledgment code.”

1400 will now wait 10 seconds for a Touch-Tone acknowledgment code to be entered. After the last digit of the acknowledgment code has been received, the 1400 will respond by saying: “Alarm Acknowledged.” The alarm has been acknowledged and the unit will hang up. Once the alarm has been acknowledged, the dialout process stops.

If a Touch-Tone acknowledgment code is not received, the 1400 will offer you a second chance to enter it, responding with: “beep,” “error,” “Enter acknowledgment code.” If the acknowledgement code is still not received, then the 1400 will respond by saying: “beep,” “error,” “goodbye.” The alarm has not been acknowledged. The 1400 will hang up and wait the programmed INTERCALL TIME before making the next phone call. During this time you may call the unit back from a Touch-Tone phone and the unit will give a voice report. Once you receive the complete report, enter the code to acknowledge the alarm.

**NOTE:** An alarm cannot be acknowledged using a pulse (rotary) telephone unless the *Callback Acknowledgment* feature is enabled.

## Alarm Acknowledgment—Numeric Pager Dialout

The 1400 will dial out to your pager service and leave a number on the display of your beeper. (See *Chapter Five*) The unit will then hang up without speaking a voice message and wait for you to call back and enter an acknowledgment code. This waiting period is called the INTERCALL TIME. During this time you may call the unit back from a Touch-Tone phone to receive a report of the alarm condition and acknowledge the alarm by entering the acknowledgment code.

**NOTE:** An alarm cannot be acknowledged using a pulse (rotary) telephone unless the *Callback Acknowledgment* feature is enabled.

Below is an example of what the 1400 will say when you call it back to acknowledge a typical alarm:

“Hello, this is 555-2278, ‘Acme Medical Laboratory,’ Zone One, ‘Temperature in Refrigerator One,’ a high temperature alarm exists, it is now 50 degrees Fahrenheit, too high. Listen to sound for ten seconds.”

“Enter acknowledgment code.”

The 1400 will now wait 10 seconds for a Touch-Tone acknowledgment code to be entered. After the last digit of the acknowledgment code has been received, the 1400 will respond by saying: “Alarm Acknowledged.” The alarm has been acknowledged and the unit will hang up. Once the alarm has been acknowledged, the dialout process stops.

If a Touch-Tone acknowledgment code is not received, the 1400 will offer you a second chance to enter it, responding with: “beep,” “error,” “Enter acknowledgment code.” If an acknowledgement code is still not received, then the 1400 will respond by saying: “beep,” “error,” “goodbye.” The alarm has not been acknowledged. The 1400 will hang up and wait for you to call back and enter the acknowledgment code. This waiting period is called the INTERCALL TIME. During this time you may call the unit back from a Touch-Tone phone and the unit will give a voice report. Once you receive the complete report, enter the code to acknowledge the alarm.

**NOTE:** An alarm cannot be acknowledged using a pulse (rotary) telephone unless the *Callback Acknowledgment* feature is enabled.

**TIP:** When the 1400 is programmed to make calls to pagers, make sure the intercall delay time is long enough to give the person carrying the pager some time to get to a phone to call the unit back.

### **Alarm Acknowledgment—Automatic (Max Calls)**

The 1400 has the ability to acknowledge itself by using the Max Calls function. The unit keeps a count of the number of phone calls it makes for a particular alarm. Once the number of calls made reaches Max Calls, the 1400 will acknowledge the alarm and stop the dialout process. The default setting for Max Calls is 100.

## **CALL-IN STATUS**

You can also call into the 1400 using a Touch-Tone telephone to obtain a status report. After answering, the 1400 will recite a status report. Immediately following the status report, the 1400 allows you to use Touch-Tone commands to enable/disable zones, change limits, control the output, etc. See the next section, Remote Commands via Touch-Tone Phone.

Below is an example of a voice status report:

“Hello, this is 555-2278, ‘Acme Medical Laboratory’

“Zone one, ‘Temperature in refrigerator one,’ 38 degrees Fahrenheit, OK

“Zone two, ‘Temperature in refrigerator two,’ 40 degrees Fahrenheit, OK

“Zone three, ‘Water pressure monitor,’ OK

“Zone four, ‘Nitrogen gas tank level in percent,’ 15, too low, acknowledged alarm exists

“Sound is OK”

“Power is ON”

“Battery is OK”

“Output is off.”

“Good-Bye”

## REMOTE COMMANDS VIA TOUCH-TONE PHONE

You can issue a number of commands to the 1400 remotely using a Touch-Tone telephone. This command mode can be entered at any time during the status report. Simply press a Touch-Tone and the unit will halt the report and respond with “OK.” You are now in Touch-Tone command mode. Commands are available to perform the following functions:

- Enable and disable zones, power monitoring, and sound monitoring
- Recite/Set High and Low alarm limits
- Recite/Set telephone numbers
- Record/Play custom voice messages
- Recite/Set the relay output
- Activate the microphone for listen-in
- Recite status report
- Recite alarm history

The commands are put together based on the letters of a touch-tone telephone. See typical telephone keypad layout below.



*Figure 1: A telephone keypad*

Many of the commands use three letters that represent an abbreviation of the selected command. For example, to Set a High limit on Zone 1 you would press S + H + 1 (or in numeric form 7 + 4 + 1)

The tables below list all of the touch-tone commands that are supported. Commands are listed in both character and numeric formats. The # key is used as an ENTER key. Use the \* key to represent a negative sign or to represent the [CODE] key when programming telephone numbers.

## Enable/Disable Zones

This command will toggle the selected zone between the enabled or disabled state.

<u>Description</u>	<u>Touch-Tone Command</u>
Enable/Disable Zone	* + Z(0) + (zone number)

## Set and Recite High & Low Alarm Limits

The following commands are used to set or recite the Low Alarm Limit for any Zone.

<u>Description</u>	<u>Touch-Tone Command</u>
Set Zone Low Limit	S(7) + L(5) + (zone number) + (value) + #

<u>Description</u>	<u>Touch-Tone Command</u>
What Is Zone Low Limit	W(9) + L(5) + (zone number)

The following commands are used to set or recite the High Alarm Limit for any Zone.

<u>Description</u>	<u>Touch-Tone Command</u>
Set Zone High Limit	S(7) + H(4) + (zone number) + (value)+ #

<u>Description</u>	<u>Touch-Tone Command</u>
What Is Zone High Limit	W(9) + H(4) + (zone number)

## Set and Recite Telephone Numbers

The following commands will allow you to program and recite dialout telephone numbers. You may need to use the Special Dialing Codes below.

*Special Dialing Codes Summary*

Code 1: Numeric pager type

Code 2: Wait for answer

Code 3: Change to Touch-Tone

Code 4: Pause

Code 5: \*

Code 6: #

<u>Description</u>	<u>Touch-Tone Command</u>
Setting a phone number	S(7) + T(8) + (entry 1–8) + (telephone number) + #

<u>Description</u>	<u>Touch-Tone Command</u>
Reciting a phone number	W(9) + T(8) + (entry 1–8)

**Record and Play Custom Voice Messages**

The following commands will allow you to record and play back custom voice messages for the ID message (0) and each zone (1–4).

<u>Description</u>	<u>Touch-Tone Command</u>
Record a Message	S(7) + M(6) + (entry 0–4)

<u>Description</u>	<u>Touch-Tone Command</u>
Play a Message	W(9) + M(6) + (entry 0–4)

**Control the Relay Output**

The following commands will allow you to check the status of the relay output and to toggle the Relay Output On and Off.

<u>Description</u>	<u>Touch-Tone Command</u>
Reciting the Output Status	W(9) + R(7) + O(6)

<u>Description</u>	<u>Touch-Tone Command</u>
Switching the Output	S(7) + R(7) + O(6)

**Activate Microphone Listen-in**

The following command will allow you to activate the microphone listen-in for the programmed duration.

<u>Description</u>	<u>Touch-Tone Command</u>
Activate Mic Listen-in	M(6) + I(4) + C(2)

## Request Status Report

The following command will initiate a status report.

<u>Description</u>	<u>Touch-Tone Command</u>
Recite status report	W(9) + S(7) + R(7)

## Request Alarm History

The following command will recite the alarm history.

<u>Description</u>	<u>Touch-Tone Command</u>
Recite alarm history	H(4) + I(4) + S(7)

## Hang-up

The following command will make the 1400 hang up the telephone line.

<u>Description</u>	<u>Touch-Tone Command</u>
Hang-up the phone line	B(2) + Y(9) + E(3)

**NOTE:** If a security code is enabled, the 1400 will prompt you with “Enter security code.” Enter the four-digit keypad security code plus “#” to enter touch-tone command mode. If entered correctly, the 1400 will respond with “OK” and you can proceed to enter the commands. If entered incorrectly, the unit will give you one more chance. If it is incorrect a second time, the unit will say “Error, goodbye” and hang up.

## **APPENDIX A: Checking Your Sensaphone 1400 for Proper Operation**

We recommend that you test your Sensaphone 1400 weekly to be sure it is functioning properly. This will ensure that when a problem arises the 1400 will be ready to alert the appropriate personnel. Phonetics, Inc. also recommends you keep a log of performed tests, and has provided you with a Test Log template at the back of this manual.

There are several tests that can be performed:

1. Call the unit and listen to the Status Report. This will test the unit's ability to answer the phone and speak a message. It will also verify that the inputs are reading properly, the alarm conditions are OK, the electricity is on, the microphone is functioning (optional), and that the batteries are OK.
2. Create a test alarm on each input and allow the unit to contact all programmed telephone numbers. This will make sure that the 1400 is programmed properly. It will also prepare personnel to respond appropriately when they receive a call from the 1400. Listed below are suggestions on how to trip test alarms:
  - Temperature sensors: Heat or cool the sensor.
  - Motion sensors: Have someone walk in front of the sensor.
  - Door/window sensors: open the door/window.
  - Water sensors: Apply a small amount of water beneath the sensor or use a wet towel and touch it to the sensor probes.
  - Humidity sensors: Raise the humidity around the sensor by holding a cup of very hot water beneath the sensor.
  - NO/NC Contacts: Open or close the contact.

Allow the unit to contact all programmed telephone numbers. This will make sure that the 1400 is programmed properly. It will also prepare personnel to respond appropriately when they receive a call from the 1400.

3. Test the batteries by unplugging the AC adapter and making sure that the 1400 continues to function. Check that the BATTERY OK LED remains on steady. Press WHAT IS, then STATUS on the keypad, and listen to the status report. Make sure the report states that “power is off” and “battery is OK.” Keep the AC adapter unplugged so that a Power Failure alarm occurs. Allow the unit to dial all programmed telephone numbers while running on battery backup. Plug in the AC adapter after the unit has finished dialing all of the telephone numbers.

## APPENDIX B: Replacing the Back-up Battery

The back-up battery will provide about 3–5 years of service life depending on usage and temperature. After 5 years (or when back-up time is insufficient) the battery should be replaced. Replacement batteries can be ordered from Sensaphone (*Part number BAT-0020*). To replace the battery, follow the instructions below:

**WARNING:** When removing and replacing the battery, be careful not to short out the battery terminals on the bracket or back panel. A large spark and/or battery damage could result.

1. Turn the power switch off and unplug the power transformer.
2. Loosen the compression wiring connectors and allow 6-10" of cable slack to come into the enclosure. This will make it easier to turn the panel over.
3. Remove the four corner screws securing the keypad/pcb panel and turn the panel over.
4. Remove the connectors from the battery by carefully pulling and wiggling the connectors from the battery tabs.
5. Remove the screws holding the battery bracket and remove the bracket.
6. Dispose/Recycle the old battery following local disposal regulations for lead batteries.
7. Attach the battery connector at the end of the BLACK wire to the -(negative) terminal of the new battery.
8. Attach the battery connector at the end of the RED wire to the +(positive) terminal of the new battery.
9. Insert the new replacement battery into the slot and replace the bracket. Secure the bracket with the two screws.
10. Place the main panel over the four metal stand-offs and reattach the four corner screws.

11. Readjust the cables through the compression connectors and secure the fittings.
12. Plug the power transformer into the outlet and turn on the power switch.

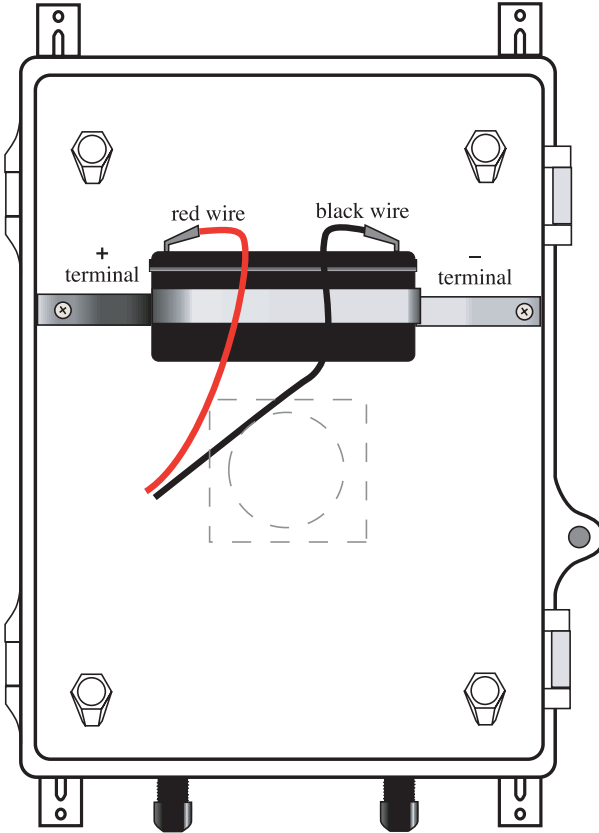

Figure 1: Back-up Battery placement

## **APPENDIX C: Troubleshooting the 1400**

In the event that a problem is encountered, this section will assist you in determining the cause so you can return the unit to its normal monitoring routine with minimal interruption.

Most problems with the 1400 are easy to identify and quickly corrected. See the information under the following general headings:

- Communications/Dialout functions
- Temperature monitoring
- 4–20mA monitoring
- Sound level monitoring
- Other monitoring functions

If you have tried the solutions outlined in this section and are not satisfied with the results, call Sensaphone Technical Support toll-free at 1-877-373-2700. If it is determined that your 1400 requires repair please follow the instructions in Appendix H for returning your unit for service.

## COMMUNICATIONS/DIAL-OUT:

### Problem 1

The 1400 fails to dial out.

---

#### Cause

- a) The telephone number may be incorrectly programmed.
- b) Tone or pulse (the current dialing method) is not compatible with the telephone line on which the 1400 is installed.
- c) Recognition Time is too long. An alert condition does not remain in effect long enough to become a valid alarm.
- d) Max Calls is set to zero.
- e) The 1400 is connected to an incompatible telephone line.

#### Solution

- Recheck programming steps and use the dial-out test mode to listen to the unit dial. Refer to Chapter 5.
  - Switch from the current setting: from tone to pulse, or from pulse to tone. Refer to Chapter 5.
  - Reprogram Recognition Time. Set the Recognition Time to the minimum duration required to create a valid alarm. If possible, test the new setting by deliberately creating an alert condition. Refer to Chapter 4.
  - Reprogram Max Calls. It is a good idea to set your Max Calls to at least equal the number of dial-out telephone numbers programmed. Refer to Chapter 5.
  - The 1400 must be connected to a standard (2-wire analog) telephone line, not a digital extension to a phone system. If the unit will not dial out and the factors previously listed have been ruled out, try connecting the unit to a standard residential telephone line.
-

## Problem 2

The 1400 will not answer the telephone when called for a Status Report or alarm acknowledgment.

---

### Cause

- a) Rings Until Answer is incorrectly programmed.
- b) The 1400 is connected to an incompatible telephone line.

### Solution

Recheck programming of Rings Until Answer. Refer to Chapter 5.

Some telephone systems will not allow the telephone to ring beyond 4 rings. If your 1400's Rings Until Answer is set at more than 4 rings, you may not be able to access the unit. Try setting the Rings Until Answer to less than 4 rings. If this does not correct the problem, it may indicate telephone line incompatibility. In this case, try connecting the 1400 to a standard, residential telephone line.

---

## Problem 3

The 1400 will not answer the telephone for Callback Acknowledgment.

---

### Cause

You did not allow the telephone to ring 10 times. Note: If the TAD (telephone answering device) is disabled, the telephone rings ten times before the 1400 answers. If the TAD is enabled, you must call and let the line ring once; hang up and call back again within 30 seconds. The 1400 will answer on the first ring and acknowledge the alarm.

### Solution

When calling the 1400, and the TAD is disabled, allow the telephone to ring 10 times. Refer to Chapter 5.

## COMMUNICATIONS/DIAL-OUT *(continued)*

### Problem 4

The 1400 recites the alarm message or Status Report over the telephone, but is silent at the installation site.

---

**Cause**

The local voice mute feature is in effect.

**Solution**

Deactivate local voice mute. Refer to the programming steps in Chapter 5.

---

### Problem 5

The 1400 and telephone answering device (sharing the same line) answer incoming calls simultaneously.

---

**Cause**

The 1400's number of Rings Until Answer is set to equal the number of rings set for the telephone answering device.

**Solution**

Change the number of Rings Until Answer for the 1400. Refer to Chapter 5.

---

**TEMPERATURE MONITORING:****Problem 1**

Can't program temperature limits; or the unit won't read the temperature sensor.

**Cause**

The zone isn't configured to read a temperature sensor.

**Solution**

Press SET and CONFIGURE to program the zone. For 10K thermistor, you must manually configure. See Chapter 4.

**Problem 2**

The temperature reading is -121° F or -85° C [2.8K];  
or -87° F or -85° C [10K].

**Cause**

The temperature sensor has been disconnected or has broken wires.

**Solution**

Examine the wires to temperature sensor and connect or replace wiring.

**Problem 3**

The temperature reading is 115° F or 57° C [2.8K];  
or 168° F or 76° C [10K].

**Cause**

Temperature sensor wires are touching or have shorted.

**Solution**

Verify and correct wiring.

## TEMPERATURE MONITORING *(continued)*

### Problem 4

Temperature reading is inaccurate.

---

#### Cause

- a) The zone is configured for the wrong type of thermistor (i.e., 2.8k vs. 10k)
- b) Temperature sensing may be affected by a source of ambient heat (ie., direct sunlight, or heat duct proximity).
- c) Temperature may require calibration.
- d) The unit is using the wrong temperature scale (Fahrenheit vs. Celsius).

#### Solution

- Manually configure the zone as described in Chapter 4.
  - Try moving the sensor to a different location.
  - After moving or placing the sensor away from ambient heat sources, the temperature may be calibrated to offset inaccurate normal reading by several degrees.  
Refer to Chapter 4.
  - Verify temperature scale.  
Refer to Chapter 4.
-

## 4–20mA MONITORING:

### Problem 1

Can't program 4–20mA range; or the unit won't read the 4–20mA sensor.

---

#### Cause

The zone isn't configured to read a 4–20mA sensor.

#### Solution

Press SET and CONFIGURE to program the zone. See Chapter 4 for information on zone configuration.

---

### Problem 2

The zone input is not reading correctly.

---

#### Cause

- a) No power connected to the transducer.
- b) Incorrect wiring.
- c) The table range is incorrectly programmed.
- d) The input is not configured for 4–20mA.
- e) Multiple devices connected in loop.

#### Solution

- Connect a power supply as shown in Chapter 2.
  - Inspect wiring. Make sure polarity is correct as shown in Chapter 2.
  - Program the table range for the calibrated range of the transducer.
  - Configure the zone for 4–20mA. Refer to Chapter 4.
  - The 1400's zone is single-ended and terminates to ground. Because of this, the 1400 must be the last device in the loop, and in some cases the ONLY device. For certain installations, it may be necessary to use a signal isolator.
-

## SOUND LEVEL MONITORING:

### Problem 1

False high sound alarms occur frequently.

---

#### Cause

a) The programmed sound sensitivity results in over-sensitivity to non-alarm sound as well as alarm sound.

b) Sound Recognition Time is too short.

#### Solution

Reprogram the sound sensitivity (calibration). Refer to Chapter 4.

Lengthen the sound Recognition Time. Refer to Chapter 4.

---

### Problem 2

High sound does not cause an alarm.

---

#### Cause

a) The microphone is not close enough to the high sound source, or the programmed sound setting results in a lack of sensitivity to high sound.

b) No remote microphone (optional) connected to the unit.

#### Solution

Move the microphone closer or reprogram the sound sensitivity. Refer to Chapter 4.

Connect a remote microphone to the Mic terminals.

---

**OTHER MONITORING:****Problem 1**

Alarm status of a zone is incorrect.

**Cause**

Incorrect zone configuration.

**Solution**

Reconfigure the zone. See Chapter 4.

**Problem 2**

False power-out alarms.

**Cause**

Programmed Recognition Time is too short.

**Solution**

AC power may be subject to brief interruptions. To avoid frequent, false alarms, increase the power Recognition Time. Refer to Chapter 4.

**Problem 3**

The 1400 does not recognize power failure.

**Cause**

- a) Battery is either incorrectly installed or drained.
- b) Recognition time setting is too long.

**Solution**

To verify proper battery function, unplug the unit and verify continued operation using battery only. If unit ceases to function, replace the battery. Refer to Appendix B.

Reprogram Recognition Time. Set the Recognition Time to the minimum required before a valid alarm occurs. If possible, test the condition by deliberately creating an alert condition. Refer to Chapter 4.

## OTHER MONITORING (continued)

### Problem 4

The 1400 does not recognize any alarm.

---

<b>Cause</b>	<b>Solution</b>
a) Zones for alarm are disabled.	Enable the zones for alarm. See Chapter 4.
b) Programmed Recognition Time is too long.	Reprogram Recognition Time. Set the Recognition Time to the minimum required for a monitored condition to become a valid alarm. If possible, test the condition by deliberately creating an alert condition. Refer to Chapter 4.

---

### Problem 5

The batteries drain prematurely.

---

<b>Cause</b>	<b>Solution</b>
The unit's AC transformer is unplugged or for some other reason full AC power is not available to the unit.	The batteries will take over powering the unit when the AC transformer is unplugged from the 120 VAC outlet. When storing the unit, be sure to turn the power switch off.

---

If the solutions offered above do not appear to correct the problem, apply the following steps, in the order shown.

- Turn the power switch off.
- Wait one minute for the 1400 to completely power down.
- Turn the power switch on.
- Reconfigure the zones. Refer to Chapter 4.

Refer to Chapter 2, Installation, for additional information on batteries and installation procedures. Contact Sensaphone Technical Support toll-free at 1-877-373-2700.

## APPENDIX D: 2.8 and 10K Thermistor Tables

### 2.8K Thermistor Data

Degrees Celsius	Resistance (Ohms)
-50	187,625
-40	94,206
-30	49,549
-20	27,180
-10	15,491
0	9,142
10	5,572
20	3,498
30	2,256
40	1,491
50	1,009
60	697
70	490
80	351

**10K Thermistor Data**

Degrees Celsius	Resistance (Ohms)
-30	135.2K
-20	78.91K
-10	47.54
0	29.49K
10	18.79K
20	12.25K
30	8,194
40	5,592
50	3,893
60	2,760
70	1,990

## APPENDIX E: 1400 Technical Specifications

### Environmental Inputs

**Number of Zones:** 4

**Zone Connector:** terminal block

**Zone Types:** N.O./N.C. contact, 2.8K (-109° to 115° F; -85° to 57° C), and 10K thermistor (-87° to 168° F; -66° to 76° C), and 4–20mA (-10,000 to 10,000)

**Zone characteristics:** 28K $\Omega$  to 2.5V (temperature/contact) or 250 Ohms to ground (4–20mA)

**A/D Converter Resolution:** 10 bits  $\pm$ 2 LSB

**Zone Protection:** Metal oxide varistors, and fast-acting diode clamps

### Microphone

**Internal:** for recording custom voice messages

**External (optional):** For listening in to on-site sounds and high sound level alarms

- Mic Connector: terminal block
- Mic Type: Electret Condenser
- Mic Impedance: 2.2K $\Omega$

### Phone Interface

**Terminals** for connection to a two-wire analog telephone line

**Line seizure** terminals for connecting extension telephone devices

**LED Indicators:** (4) Zone Alarms, Sound, Power, Battery OK, Phone in Use, Output On, and System On

**Relay Output:** 2A 120VAC/2A 24VDC—Programmable for automatic or manual switching

## **Power Supply**

**Power Supply:** 120VAC/12VDC 60Hz 6W wall plug-in transformer  
(230VAC/12VDC 50/60Hz power supply optional)

**Power Consumption:** 5 Watts

**Power Protection:** Metal Oxide Varistor

**Battery Backup:** 6V 1.3 AH sealed gel cell, provides up to 24 hours of back-up time

## **Environmental**

**Operating Temperature:** 32–122 deg F (0–50 deg C)

**Operating Humidity:** 0–90% RH non-condensing

**Storage Temperature:** 32–140 deg F

## **Physical**

**Dimensions:** 12.1"h x 7.3"w x 4.5"d

**Weight:** 5 lbs.

### **Enclosures:**

- Solid Door Enclosure: ABS/PC Blended Plastic, UL94-5VB Flammability rating, NEMA Type 1, 2, 3, 3R, 4, 4X, 12 & 13, IEC529, IP66.
- Clear Door Enclosure: ABS/PC blended plastic, UL94-5VB flammability rating; UV stabilized. NEMA Type 1, 2, 3, 3R, 4, 4X, 12 & 13, IEC529-IP65.

### **Standards**

- FCC Part 15 Class A, USA Emission Standards
- FCC Part 68 (47 C.F.R. Part 68), USA Telecommunications Standards
- ICES-003 Issue 4 Class A, Canadian Emission Standards
- Complies with CS-03 Issue 8, Canadian Telecommunications Standards
- NRTL Listed for compliance to UL60950-1, USA Safety Standards
- NRTL Listed for compliance to CSA C22.2 No. 60950-1, Canadian Safety Standards

# APPENDIX F: 1400 Quick Reference Guide

## Communications

<b>ID Number</b>	Identification number of the 1400 [SET] or [WHAT IS] + [ID/POWER] Range=0–16 digits, Default=blank
<b>ID Message</b>	Custom message identifying the 1400 [SET] or [WHAT IS] + [MESSAGE] + [ID/POWER] Max: 8 seconds Default=N/A
<b>Zone Message</b>	Message identifying the zone in alarm [SET] or [WHAT IS] + [MESSAGE] + [zone #] Max:5 seconds Default=N/A
<b>Voice Repetitions</b>	Number of times alarm message is repeated over the phone [SET] or [WHAT IS] + [VOICE REPS] Min: 1 reps, Max: 10 reps Default=3 reps
<b>Dial-Out Phone Numbers</b>	Phone numbers dialed to report alarm conditions [SET] or [WHAT IS] + [PHONE NUMBER] + [number 1–8] Max: 8 numbers, 48 digits each Default=N/A
<b>Call Delay</b>	Time delay until first call is made [SET] or [WHAT IS] + [CALL DELAY] (min:sec) Min: 00:00 Max: 60:00 Default=00:30
<b>Intercall Time</b>	Time delay between phone calls [SET] or [WHAT IS] + [INTERCALL TIME](min:sec) Min: 00:10, Max: 60:00 Default=00:30
<b>Max Calls</b>	Number of calls until unit self-acknowledges [SET] or [WHAT IS] + [MAX CALLS] Min: 0 calls, Max: 255 calls Default=100 calls
<b>(TAD) Answering Device Compatibility</b>	Allows 1400 to bypass answering devices on the same line [SENSOR ON/OFF] + [RINGS/TAD/*] On or Off, Default=Off
<b>Rings Until Answer</b>	Number of rings until unit answers an incoming call [SET] or [WHAT IS] + [RINGS/TAD/*] Min: 1 ring, Max: 15 rings DEFAULT=4 rings
<b>Speaker Mute</b>	Turns off the speaker during alarm conditions [SENSOR ON/OFF] + [MESSAGE/MUTE] On or Off Default=Off
<b>Call Progress</b>	Disables call progress detection feature [SENSOR ON/OFF] + [STATUS/CONFIGURE] On or Off Default=On

**Callback Acknowledgment** Allows alarm acknowledgment with 10 rings  
[SENSOR ON/OFF] + [CODE]  
On or Off Default=Disabled (*off*)

**Tone or Pulse Dialing** Dialing method—touch-tone or pulse  
[SENSOR ON/OFF] + [PHONE NUMBER T/P]  
Tone or Pulse Default=Tone

## Alarm Programming

**Temp Alarm Limits** High and low temperature alarm limits  
[SET] or [WHAT IS] + [ALARM LIMITS]+[zone #]  
Min: -109°F/-65°C Max:168°F/76°C Default=Low: 0°F; High:100°F

**4–20mA Table Range** Defines upper and lower range of 4–20mA sensor  
[SET] or [WHAT IS] + [TABLE RANGE] + [zone #]  
Min: -10,000, Max: 10,000 Default=Low: 0, High:100

**4–20mA Alarm Limits** High and low alarm limits  
[SET] or [WHAT IS] + [ALARM LIMITS] + [zone #]  
Min: -10,000, Max: 10,000 Default=Low: 0, High: 100

**Zone Calibrate** Offset correction factor [temp/4-20mA]  
[SET] or [WHAT IS] + [CALIBRATE] + [zone #]  
Min: -15°/-100, Max: 15°/100 Default=0

**Auto. Zone Configuration** Automatically configures all zones.  
[SET] + [STATUS/CONFIGURE] + 0  
Default=n/a

**Manual Zone Configuration** To configure an individual zone type (*required* for 10K Temp)  
[SET] + [STATUS/CONFIGURE] + [zone #] + [type]  
1 = NO, 2 = NC, 3 = 2.8K Temp, 4 = 10K 5 = 4–20mA  
Default=n/a

**Recognition Time Zones 1–4** Length of time a fault condition must exist to trip an alarm  
[SET] or [WHAT IS] + [REC TIME] + [zone #]  
Min:00:00, Max: 540:00 Default=00:03 (min:sec)

**Rec Time: Power Failure** Length of time the power must be off to trip an alarm  
[SET] or [WHAT IS] + [REC TIME] + [POWER]  
Min: 00:00, Max: 540:00 Default=05:00 (min:sec)

**Rec Time: High Sound Level** Length of time the sound must be high to trip an alarm  
[SET] or [WHAT IS] + [REC TIME] + [SOUND]  
Min: 00:05, Max: 00:60 Default=00:08 (min:sec)

**Sound Level Alarm Sensitivity** Microphone sensitivity for high noise level alarm  
[SET] or [WHAT IS] + [CALIBRATE] + [SOUND]  
Min: 1 (most), Max: 160 (least) Default=32

**Enable/Disable Zone** Turns zone alarm detection on or off  
[SENSOR ON/OFF] + [zone #]  
On or Off Default=Enabled (*on*)

<b>Reset Time</b>	Length of time until an alarm resets [SET] or [WHAT IS] + [RESET TIME] + [Zone #] 0={disabled} Min:30, Max:1440, Default = 0
<b>Power Alarm Enable/Disable</b>	Turns power alarm detection on or off [SENSOR ON/OFF] + [POWER] On or Off Default=Enabled (on)
<b>Sound Alarm Enable/Disable</b>	Turns high sound level alarm detection on or off [SENSOR ON/OFF] + [SOUND] On or Off Default=Enabled (on)
<b>Temperature Scale</b>	Selects between Fahrenheit and Celsius [SENSOR ON/OFF] + [TEST/°F/°C] Fahrenheit or Celsius Default=Fahrenheit
<b>Temperature-Only Status Report</b>	A limited status report that only includes inputs configured as temperature. [WHAT IS] + [TEST]
<b>Designating a Zone Unused</b>	Removes zone from status and alarm reports [SENSOR ON/OFF] + [SET] + [zone #] On or Off Default=on

## Special Functions

<b>Dial-Out Test Mode</b>	Simulates alarm to test telephone programming [SET] + [TEST] + [# key 1-8] Default=none
<b>Listen-In Time</b>	Length of listen-in time during call-in status report [SET] or [WHAT IS] + [LISTEN TIME] Min: 0 sec, Max: 255 sec Default=00:00 (min:sec)
<b>Acknowledgment Code</b>	To create an individual user's 4-digit acknowledgment code [SET] + [CODE] + [# key 1-8] Default=555 for single-user mode
<b>Date &amp; Time</b>	Internal clock/calendar [SET] or [WHAT IS] + [DATE/TIME/#] Date: mmddyy, Time: hhmm Default=none
<b>Alarm History</b>	Recites last 10 alarms [WHAT IS] + [HISTORY] Default=n/a
<b>Reset History</b>	Clears the alarm history [SET] + [HISTORY] Default=n/a
<b>Switch Output</b>	Turns output relay on or off (in manual mode) [SENSOR ON/OFF] + [OUTPUT] On or Off Default=off

<b>Output Mode</b>	Program relay output as manual or automatic for specific zone [SET] or [WHAT IS] + [OUTPUT] + [mode number] Default=none
<b>Remote Security</b>	Prohibits programming changes via telephone [SET] or [WHAT IS] + [ENTER/LOCK] + [4 digit code] Default=unlocked

Press [ENTER] after all Key Sequences starting with [SET].  
Use [SET] to establish parameters, [WHAT IS] to verify them.

## SPECIAL KEY FUNCTIONS

### RING/TAD/\*

Used to enter a minus sign for negative alarm limits or calibrations.

### DIALOUT CODES

- CODE 1 Numeric pager call type
- CODE 2 Inserts a “Wait for answer”
- CODE 3 Change to Touch-Tone dialing
- CODE 4 Pause
- CODE 5 \*
- CODE 6 #

## APPENDIX G: Accessories

The sensors and accessories listed below are available from Phonetics, Inc., and represent the most commonly used devices. Other dry contact sensors or 4–20mA transducers, designed for more specialized applications, may also be used. Commercial or industrial electrical supply houses can provide devices to monitor virtually any condition. For further information, contact a Sensaphone Sales Associate toll-free at 1-877-373-2700.

<u>PART NUMBER</u>	<u>SENSOR/ SWITCH</u>
FGD-0006	Magnetic Reed Switch
FGD-0007	Passive Infra-Red Detector
FGD-0010	50' two-conductor #22AWG shielded accessory Cable
FGD-0013	Spot Water Detector
FGD-0022	Temp° Alert
FGD-0023	ISOTEL Surge Protector
FGD-0027	Humidistat
FGD-0049	Smoke Detector with Built-in Relay
FGD-0052	Humidity Transmitter
FGD-0053	24VDC Power Supply
FGD-0054	Power-Out Alert™
FGD-0056	Zone Water Detector w/Water Rope
FGD-0057	External Microphone
FGD-0060	Line Seizure Kit
FGD-0063	10' additional Water Rope for FGD-0056
FGD-0100	2.8K Remote Temperature Sensor
FGD-0101	2.8K Weatherproof Temperature Probe
FGD-0102	10K Weatherproof Temperature Probe
FGD-0205	Multipoint Wireless I/O System

## APPENDIX H: Returning Your 1400 for Repair

In the event that the 1400 does not function properly, we suggest that you do the following:

1. Record your observations regarding the 1400's malfunction.
2. Call Sensaphone Technical Support toll-free at 1-877-373-2700 or e-mail [support@sensaphone.com](mailto:support@sensaphone.com) prior to sending the unit to Sensaphone for repair. Our product support specialists are able to diagnose and correct many unit setup and programming problems over the phone.

If the unit must be sent to Phonetics, Inc. for Servicing, please do the following:

1. Turn the power switch Off, disconnect all wiring and unplug the unit.
2. Carefully pack the unit to avoid damage in transit. Use the original container (if available) or a sturdy shipping box.
3. To avoid shipping delays, you must include the following information:
  - a) Your name, address and telephone number.
  - b) A note explaining the problem.

A convenient form is available for sending your unit in for repair. Just go to [www.sensaphone.com](http://www.sensaphone.com) and click *Support*, then *Repair Services*.

4. Ship your package to the address below:

SERVICE DEPARTMENT  
Phonetics, Inc.  
901 Tryens Road  
Aston, PA 19014

5. Ship prepaid and insured via UPS or US Mail to ensure a traceable shipment with recourse for damage or replacement.

# 1400 Index

- 1400
  - Accessories 124
  - Features 18
  - Layout 19
  - LED Indicators 28
  - Operating Environment 21–23
    - Grounding 22
    - Locking the Enclosure 22
    - Mounting the 1400 21
    - Wiring Connectors 23
  - Operation 92–101
    - Alarm Acknowledgment
      - Automatic (Max Calls) 96
      - Numeric Pager Dialout 95
      - Voice Dialout 94
    - Alarm Dialout and Acknowledgment 92–93
      - Alarm Dialout-Pager 93
      - Alarm Dialout-Voice 92–93
      - Alarm Notification 92
      - Alarm Recognition 92
      - Dialout Note: Call Progress 92
    - Call-In Status 97
    - Remote Commands via Touch-Tone Phone 98–101
  - Returning for Repair 125
  - Technical Specifications 118–119
  - Telephone Line 24–25
    - Line Seizure 25
  - Troubleshooting 106–115
  - Turning the 1400 On 24
    - Backup Battery 24
  - Wiring Sensors and Transducers 25–27
    - Wiring Recommendations 27

## B

- Back-up Battery
  - Replacing 104–105

## C

- Communication Programming 51–88
  - Alarm Acknowledgment Codes 69–71
  - Alarm Dial-out Telephone Numbers 59–64
  - Numeric Pager Dialout 61–64

## *Sensaphone 1400 Manual*

- Voice Dialout 59–60
- Alarm History 72
- Callback Acknowledgment 88
- Call Delay Time 74–75
- Call Progress 79
- Date and Time 52
- Dial-Out Test Mode 67–68
- ID Number 57–58
- Intercall Time 77–78
- Listen-In Time 84
- Max Calls 81–82
- Remote Programming Security Code 85–86
- Speaker Mute 87
- Special Dialing Options 65–68
  - Change to Touch-Tone Dialing 66
  - Special Dialing Code Summary 66, 100
- TAD Compatibility 83
- Tone or Pulse Dialing 73
- Voice Messages 53–56
- Voice Repetitions 80

## **L**

- LED Indicators 28

## **O**

- Operation
  - Testing 102–103
- Output Control 89–91
  - Automatic Modes 89–90
  - Manual Mode 90–91

## **Q**

- Quick Reference Guide 120–123
- Quick Start Guide
  - Aborting a Command 29
  - Acknowledging a False Alarm 30
  - Error Messages 29–30
  - How the Keypad Commands Work 29
  - Recommended Programming Steps 30

## **T**

- Technical Support 20
- Test Log 129–130
- Thermistor Tables
  - 2.8K 116
  - 10K 117

## **W**

- Wiring Sensors and Transducers 25–27

## **Z**

- Zone Programming 31–50
  - Alarm Limits 41–43
  - Alarm Recognition Time 38–40
  - Calibration 44–45
  - Configure Range for 4-20mA sensors 35–37
  - Configure Temperature Scale 35
  - Designating a Zone as Unused 48–49
  - Enable/Disable Power 35
  - Enable/Disable Sound Level Alarm 34–35
  - Enable/Disable Zone Alarms 34
  - Exit Delay 49
  - Sound Level Calibration 46–47
  - Temperature-Only Status Report 50

